

TEMPORARY OCCLUSION CLIPS / FORCEPS

- Reliance Bulldog Clamps 6.1
- Yasargil Clips 6.4
- Heifetz™ Clips 6.6

SUNDT™ GRADUATED SUCTION SYSTEM..... 6.8

SCANLAN® CALIPER / KNIFE BLADE TOOL..... 6.10

SCANLAN® MEMORY INSTRUMENTS 6.11

VASCULAR DILATORS / VESSEL PROBES

- MEMORY Vascular Dilators / Vessel Probes 6.12

STERN™ CHEST TUBE PASSER..... 6.13

Samson™ PHLEBECTOMY HOOKS 6.14

VALVULOTOMES 6.15

AORTA / VEIN PUNCHES (Re-useable) 6.16

HAND-HELD RETRACTORS

- Pediatric 6.17
- Valve 6.18
- Hooks 6.19

RETRACTORS

- M.D.® Retractor System 6.20
- Pediatric 6.24
- Loffus™ ACDF Distractor..... 6.27

DISSECTORS..... 6.28

NERVE HOOKS & PROBES..... 6.32

PLAQUE REMOVERS 6.33

INSTRUMENT SETS

- Puskas™ Coronary Instruments – Basic Set 6.34
- Puskas™ Coronary Instruments – Supplemental Set 6.36
- Puskas™ Coronary Instruments – IMA Dissection Set 6.38
- Dura Closure Set 6.40
- Loffus™ Carotid Endarterectomy Set 6.42
- Ochsner Endarterectomy Set 6.48
- EC / IC Bypass Instrument Set 6.50
- Samson™ Phlebectomy Set 6.56



SPECIALTY

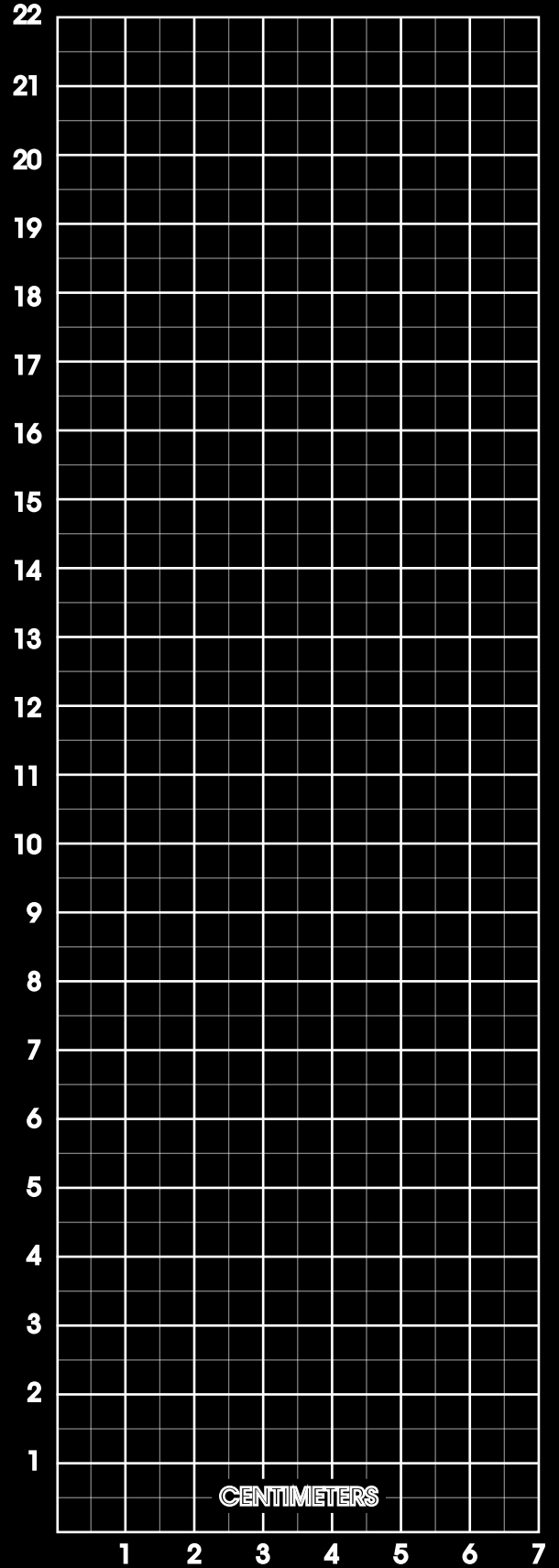
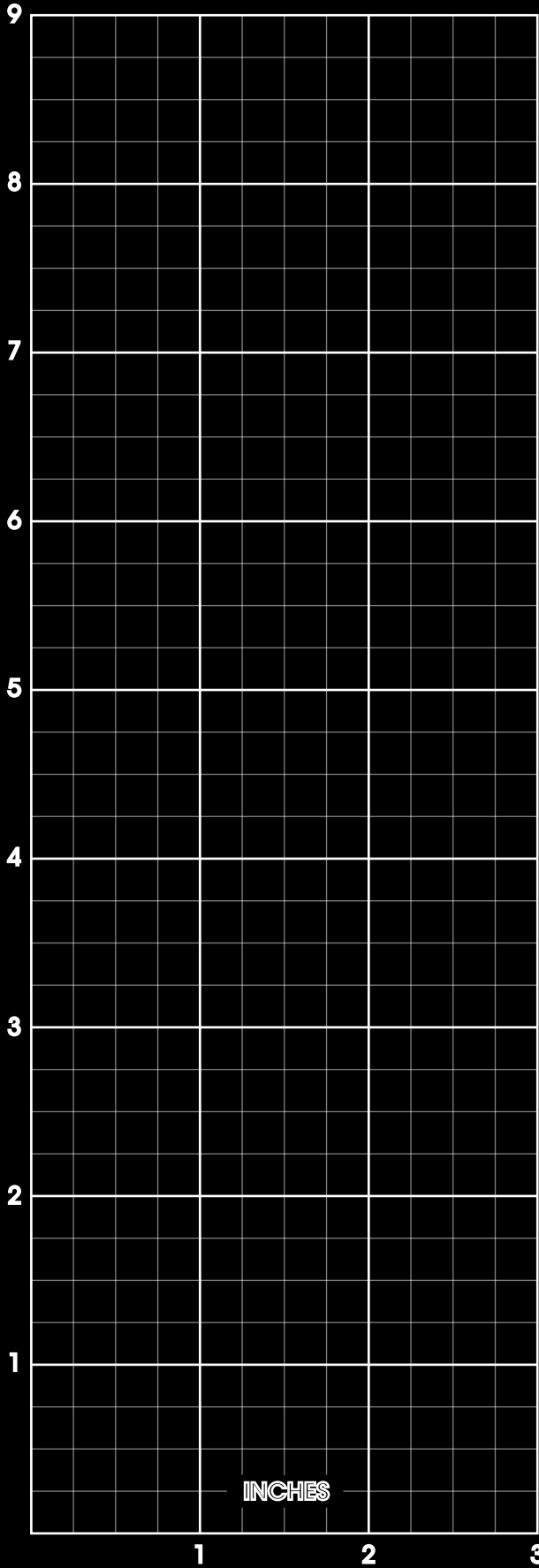







Reliance Bulldog Clamps

SPECIALTY



SCANLAN®
Reliance Bulldog Clamps
 DeBakey Jaws

		Cat. No.	Description	Total Length
Straight		3795-52	40 mm Straight DeBakey Jaws	2 3/4" (7 cm)
		3795-50	25 mm Straight DeBakey Jaws	2" (5 cm)
		3795-56	15 mm Straight DeBakey Jaws	1 5/8" (4 cm)
		3795-54	7 mm Straight DeBakey Jaws	1 1/4" (3.2 cm)
Curved		3795-51	25 mm Curved DeBakey Jaws	2" (5 cm)
		3795-57	15 mm Curved DeBakey Jaws	1 5/8" (4 cm)

Firm Sale – May Be Available For Evaluation

Please Note...

Each Scanlan instrument is individually handcrafted to provide the surgeon with the highest quality, longest-lasting, precision instrument possible. Reflecting this unique process, all stated dimensions are approximate.

Please check with your Scanlan Representative for Firm Sale status. Custom modifications available upon request. For a complete listing of models visit... www.scanlaninternational.com



Reliance Bulldog Applier / Introducer

SPECIALTY

9009-395



SCANLAN®

Reliance Bulldog Applier / Introducer

	Cat. No.	Description	Shaft	Working Length	Total Length
	9009-395	Straight Jaws With Ratchet	8 mm	13 3/4" (35 cm)	17 1/3" (44 cm)

9009-393

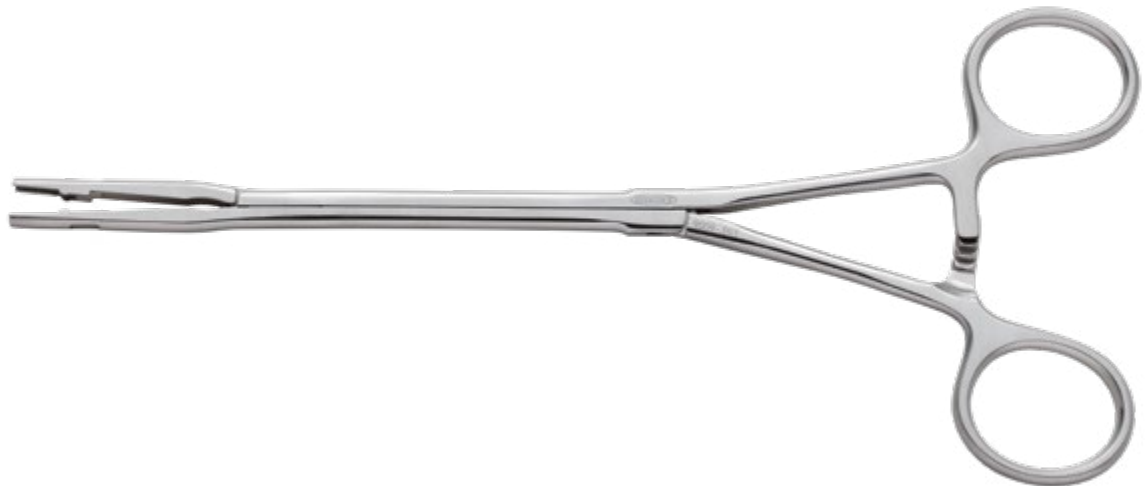

SCANLAN®

Reliance Bulldog Applier / Introducer

	Cat. No.	Description	Shaft	Working Length	Total Length
	9009-393	Straight Jaws With Ratchet	8 mm	5" (12.7 cm)	9" (23 cm)

Please Note...

Each Scanlan instrument is individually handcrafted to provide the surgeon with the highest quality, longest-lasting, precision instrument possible. Reflecting this unique process, all stated dimensions are approximate.

Reliance Bulldog Starter Pack

2135-03

SPECIALTY



2133-03

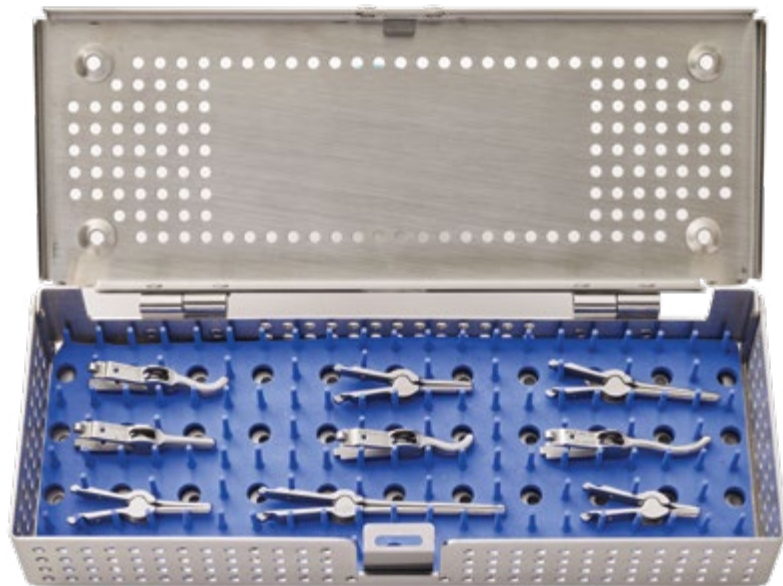

SCANLAN®

Recommended Reliance Bulldog Starter Pack

Recommended	QTY	Cat. No.	Description	Total Length
SCANLAN® V.I.P.™ Sterilization Tray	Choose 1	2133-03	SCANLAN® V.I.P.™ Micro Sterilization Tray With Scan-Guard™ Silicone Mat - Includes Hardware (Holds 3-4 Bulldogs)	1.5" x 3.5" x 1" (3.81 cm x 8.89 cm x 2.54 cm)
		2135-03	SCANLAN® V.I.P.™ Reliance Bulldog Sterilization Tray With Scan-Guard™ Silicone Mat (Holds 8-10 Bulldogs)	8 1/4" x 3 1/4" x 1 1/2" (21 cm x 8.3 cm x 3.8 cm)
Applier/Introducer	Choose 1	9009-393	Straight Jaws With Ratchet	9" (23 cm)
		9009-395		17 1/3" (44.5 cm)
SCANLAN® Reliance Bulldog Clamps	Up To 4 Of Any Combination	3795-52	40 mm Straight DeBaKey Jaws	2 3/4" (7 cm)
		3795-50	25 mm Straight DeBaKey Jaws	2" (5 cm)
		3795-56	15 mm Straight DeBaKey Jaws	1 5/8" (4 cm)
		3795-54	7 mm Straight DeBaKey Jaws	1 1/4" (3.2 cm)
		3795-51	25 mm Curved DeBaKey Jaws	2" (5 cm)
		3795-57	15 mm Curved DeBaKey Jaws	1 5/8" (4 cm)

Please check with your Scanlan Representative for Firm Sale status. Custom modifications available upon request.

For a complete listing of models visit... www.scanlaninternational.com



Yasargil Reusable Temporary Occlusion Clips/Apppliers

SPECIALTY

3786-28



SCANLAN® Yasargil Applying Forceps – Standard

Instrument jaws are shown approximate size

	Cat. No.	Description	Total Length
	3786-28	Bayonet Style Flat Handle	7 1/8" (18.1 cm)

SCANLAN® Yasargil Clips – Light Pressure

Temporary occlusion clips are shown approximate size

	Cat. No.	Description
7 mm	3785-20	Slight Curve
	3785-21	Straight
9 mm	3785-22	Straight
	3785-24	Slight Curve
11 mm	3785-26	Straight
	3785-27	Slight Curve
15 mm	3785-41	Straight
	3785-42	Slight Curve
20 mm	3785-43	Straight

SCANLAN® Yasargil Clips – Firm Pressure

Temporary occlusion clips are shown approximate size

	Cat. No.	Description
7 mm	3786-20	Slight Curve
	3786-21	Straight
9 mm	3786-22	Straight
	3786-23	Angled
	3786-24	Slight Curve
11 mm	3786-25	Strong Curve
	3786-26	Straight
	3786-27	Slight Curve
15 mm	3786-29	Strong Curve
	3786-41	Straight
	3786-42	Slight Curve
20 mm	3786-43	Straight

Please Note...

Each Scanlan instrument is individually handcrafted to provide the surgeon with the highest quality, longest-lasting, precision instrument possible. Reflecting this unique process, all stated dimensions are approximate.

Yasargil Reusable Temporary Occlusion Clips/Applicators

3786-40

SPECIALTY





SCANLAN® Yasargil Applying Forceps – Mini

Instrument jaws are shown
approximate size

	Cat. No.	Description	Total Length
	3786-40	Bayonet Style Flat Handle	8 1/2" (21.5 cm)

SCANLAN® Yasargil Clips – Mini

Temporary occlusion clips are
shown approximate size

	Cat. No.	Description
4 mm 	3786-30	Straight
6 mm 	3786-31	Straight
7 mm 	3786-32	Slight Curve

Please check with your Scanlan Representative for Firm Sale status. Custom modifications available upon request.
For a complete listing of models visit... www.scanlaninternational.com





SPECIALTY



SCANLAN®
Heifetz™ Appliers

Instrument jaws are shown
approximate size

	Cat. No.	Description	Total Length
	3795-01	Straight	7 1/4" (18.5 cm)
	3795-01A	Angled	

Heifetz™ Clips on page 6.7

Please Note...

Each Scanlan instrument is individually handcrafted to provide the surgeon with the highest quality, longest-lasting, precision instrument possible. Reflecting this unique process, all stated dimensions are approximate.





Heifetz™ Reusable Temporary Occlusion Clips/Appliers

SPECIALTY

SCANLAN®

Heifetz™ Clips – Light Pressure Black





Temporary occlusion clips are shown approximate size

	Cat. No.	Description	
	3795-04	Straight	8 mm Jaw Length 1.75 mm Jaw Width
	3795-06	Angled On Edge	
	3795-08	Curved	
	3795-20	Straight	12 mm Jaw Length 2.25 mm Jaw Width
	3795-22	Curved	

SCANLAN®

Heifetz™ Clips – Firm Pressure Gold

Temporary occlusion clips are shown approximate size

	Cat. No.	Description	
	3795-14	Straight	8 mm Jaw Length 1.75 mm Jaw Width
	3795-16	Angled On Edge	
	3795-18	Curved	
	3795-24	Straight	12 mm Jaw Length 2.25 mm Jaw Width
	3795-28	Curved	

Heifetz™ Appliers on page 6.6

Please check with your Scanlan Representative for Firm Sale status. Custom modifications available upon request.
For a complete listing of models visit... www.scanlaninternational.com



SUNDT™ Graduated Suction Sets

SPECIALTY

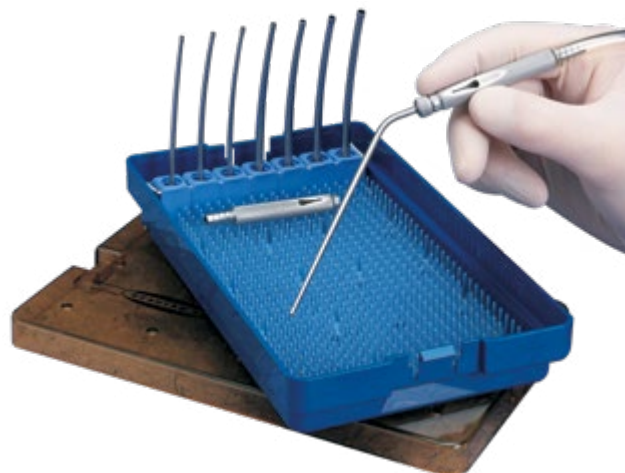

SCANLAN® SUNDT™ Graduated Suction System (Sets)

Each set includes seven suction tips, diameters (listed below), a universal suction handle (9009-930) and sterilization / storage case (9009-934)

Cat. No.	Description	3 Fr.	4 Fr.	5 Fr.	6 Fr.	7 Fr.	9 Fr.	11 Fr.
		•	•	•	•	•	•	•
9009-940	4 1/2" (11.5 cm) Rotatable Suction Tip Set	9009-941	9009-942	9009-943	9009-944	9009-945	9009-947	9009-949
9009-950	4 1/2" (11.5 cm) Non-Rotatable Suction Tip Set	9009-951	9009-952	9009-953	9009-954	9009-955	9009-957	9009-959
9009-960	5 1/4" (13.5 cm) Rotatable Suction Tip Set	9009-961	9009-962	9009-963	9009-964	9009-965	9009-967	9009-969
9009-970	5 1/4" (13.5 cm) Non-Rotatable Suction Tip Set	9009-971	9009-972	9009-973	9009-974	9009-975	9009-977	9009-979
9009-980	7 7/8" (19.8 cm) Rotatable Suction Tip Set	9009-981	9009-982	9009-983	9009-984	9009-985	9009-987	9009-989
9009-990	7 7/8" (19.8 cm) Non-Rotatable Suction Tip Set	9009-991	9009-992	9009-993	9009-994	9009-995	9009-997	9009-999

SCANLAN® SUNDT™ Graduated Suction Parts and Tray

9009-930

Cat. No.	Description	Total Length
9009-928	Brush Set, Pack Of Ten (for 9009-940 9009-950, 9009-960 and 9009-970)	
9009-928-3	Brush Set, Pack Of Ten (for 9009-941 9009-951, 9009-961 and 9009-971)	
9009-929	Brush Set, Pack Of Ten (for 9009-980 and 9009-990)	
9009-929-3	Brush Set, Pack Of Ten (for 9009-981 and 9009-991)	
9009-930	Universal Suction Handle (fits all tip lengths and French sizes)	3" (7.5 cm)
9009-934	SCANLAN® V.I.P.™ Sundt Sterilization / Storage Tray, SCAN-GUARD™ Silicone Mat (fits all tips / lengths and handle)	6" x 10" x 1.5" (15.2 x 25.4 x 3.8 cm)



Silicone mat in tray is not made with natural rubber latex.

Please Note...

Each Scanlan instrument is individually handcrafted to provide the surgeon with the highest quality, longest-lasting, precision instrument possible. Reflecting this unique process, all stated dimensions are approximate.

SUNDT™ Graduated Suction Systems

SPECIALTY

SCANLAN®
4 1/2" (11.5 cm) Tips
 for SUNDT™ Graduated Suction Systems



3 Fr. 4 Fr. 5 Fr. 6 Fr. 7 Fr. 9 Fr. 11 Fr.
 • • • • • • •

Rotatable	9009-941	9009-942	9009-943	9009-944	9009-945	9009-947	9009-949
Non-Rotatable	9009-951	9009-952	9009-953	9009-954	9009-955	9009-957	9009-959

SCANLAN®
5 1/4" (13.5 cm) Tips
 for SUNDT™ Graduated Suction Systems



3 Fr. 4 Fr. 5 Fr. 6 Fr. 7 Fr. 9 Fr. 11 Fr.
 • • • • • • •

Rotatable	9009-961	9009-962	9009-963	9009-964	9009-965	9009-967	9009-969
Non-Rotatable	9009-971	9009-972	9009-973	9009-974	9009-975	9009-977	9009-979

SCANLAN®
7 7/8" (19.8 cm) Tips
 for SUNDT™ Graduated Suction Systems



3 Fr. 4 Fr. 5 Fr. 6 Fr. 7 Fr. 9 Fr. 11 Fr.
 • • • • • • •

Rotatable	9009-981	9009-982	9009-983	9009-984	9009-985	9009-987	9009-989
Non-Rotatable	9009-991	9009-992	9009-993	9009-994	9009-995	9009-997	9009-999

SUNDT™ Graduated Suction Tips do not include Universal Suction Handle (9009-930)

Please check with your Scanlan Representative for Firm Sale status. Custom modifications available upon request.
 For a complete listing of models visit... www.scanlaninternational.com



Caliper

SPECIALTY

8008-400



SCANLAN® Caliper

Cat. No.	Description	Total Length
8008-400	Scale With Black Matte Finish, Ring Handle	11" (28 cm)

SCANLAN®

Knife Tool

8008-405

Instrument is shown approximate size

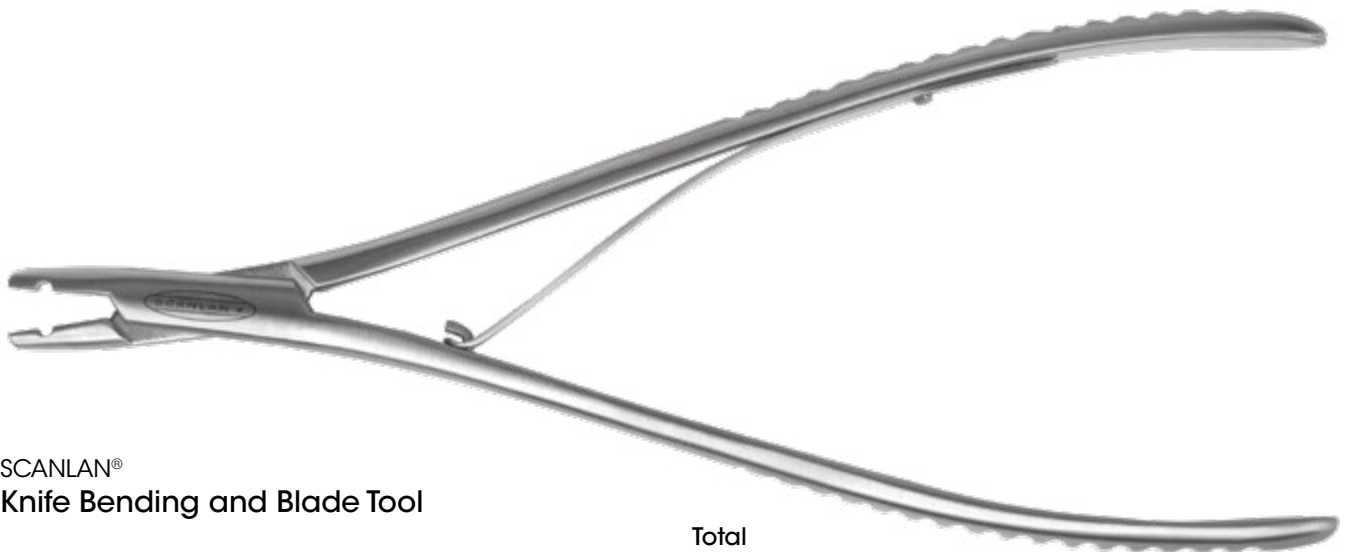

SCANLAN®

Knife Bending and Blade Tool

Cat. No.	Description	Total Length
8008-405	DIAMOND DUST™ Jaws Open Spring Handle (for use with SCANLAN® MEMORY Knife Handle 8008-410)	7" (18 cm)

Please Note...

Each Scanlan instrument is individually handcrafted to provide the surgeon with the highest quality, longest-lasting, precision instrument possible. Reflecting this unique process, all stated dimensions are approximate.

8008-430



8008-410







8008-420



SCANLAN®
MEMORY Instruments

Instrument tips are shown approximate size

	Cat. No.	Description	Total Length
	8008-410	Knife Handle, Nitinol Shaft, Stainless Steel Flat Handle, Fits #15 And #11 Blades	9 1/2" (24 cm)
	8008-420	Mirror Instrument, Nitinol Shaft, Stainless Steel Round Handle, 1.5 X Magnification, 2 Pieces (handle, mirror)	9 7/8" (25 cm)
	8008-420-4	Replacement Mirror for MEMORY Mirror Instrument (8008-420), 1.5 X Magnification	
	8008-430	Nerve Hook, Nitinol Shaft And Angled Tapered Tip, Stainless Steel Round Handle	10" (25.4 cm)
	8008-432	Nerve Hook, Nitinol Shaft And Angled Flat Tip, Stainless Steel Round Handle	10" (25.4 cm)



Note:
The detachable mirror for the SCANLAN® MEMORY Mirror Instrument is guaranteed to be free from defects in materials and workmanship for 90-days. It is not covered under the SCANLAN® 10-Year Warranty.

Nitinol is a metal alloy which is flexible and has shape memory. This means that the nitinol portion of the instrument can be bent by the user to a desired curved shape for use. The instrument will return back to its original shape when exposed to a temperature of 60°C - 90°C (140° - 194°F). Steam autoclaving exceeds this temperature and is the recommended method to return the nitinol portion of the instrument back to the original shape.

Please check with your Scanlan Representative for Firm Sale status. Custom modifications available upon request.
For a complete listing of models visit... www.scanlaninternational.com



MEMORY Vascular Dilators & Vessel Probes

SPECIALTY

8008-474

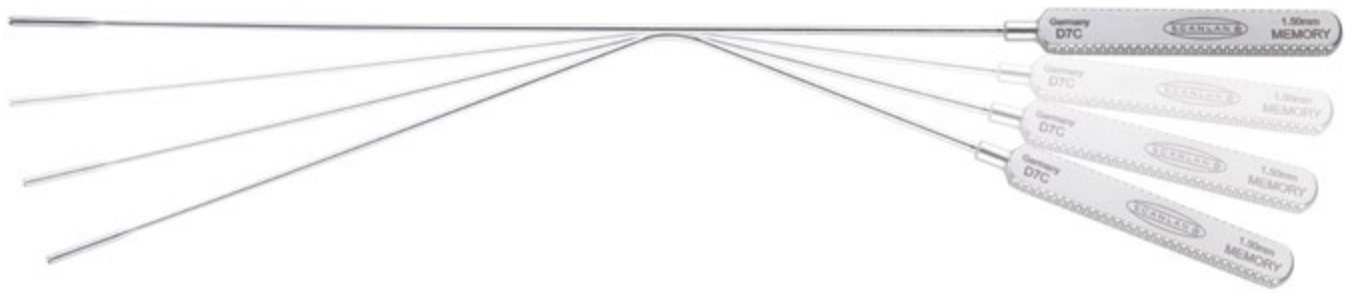

SCANLAN®

MEMORY Garrett Vascular Dilators & Vessel Probes

Shown approximate size	5 1/2" (14 cm) Cat. No.	8 1/4" (21 cm) Cat. No.	Description	Shown approximate size	8 1/4" (21 cm) Cat. No.	Description
	8008-448A	8008-449A	0.5 mm		8008-493	1 / 1.5 mm
	8008-448B	8008-449B	1.25 mm		8008-494	1.5 / 2 mm
	8008-448C	8008-449C	1.75 mm		8008-495	2 / 2.5 mm
	8008-452	8008-472	1 mm			
	8008-454	8008-474	1.5 mm			
	8008-456	8008-476	2 mm			
	8008-458	8008-478	2.5 mm			
	8008-460	8008-480	3 mm			
	8008-462	8008-482	3.5 mm			
	8008-464	8008-484	4 mm			
	8008-466	8008-486	4.5 mm			
	8008-468	8008-488	5 mm			

Please Note...

Each Scanlan instrument is individually handcrafted to provide the surgeon with the highest quality, longest-lasting, precision instrument possible. Reflecting this unique process, all stated dimensions are approximate.

4004-185

SPECIALTY



SCANLAN®

Stern™ Chest Tube Passer

Cat. No.	Description	Total Length
4004-185	Without Ratchet	9 3/4" (24.8 cm)
4004-186	With Ratchet	
4004-189	Without Ratchet	14" (35.6 cm)

Please check with your Scanlan Representative for Firm Sale status. Custom modifications available upon request.

For a complete listing of models visit... www.scanlaninternational.com



Phlebectomy Hooks

SPECIALTY



SCANLAN®
Samson™ Phlebectomy Hooks, Black Platinum Handle
Designed in cooperation with Russell H. Samson, M.D.

Cat. No.	Description	Total Length
8008-230	Right Short	4 1/4" (11 cm)
8008-232	Left Short	
8008-236	Right Long	5 1/2" (14 cm)

Firm Sale - May Be Available For Evaluation

Please Note...

Each Scanlan instrument is individually handcrafted to provide the surgeon with the highest quality, longest-lasting, precision instrument possible. Reflecting this unique process, all stated dimensions are approximate.



SCANLAN®
In Situ Valvulotomes

Cat. No.	Description	Total Length
9009-121		9" (23 cm)
9009-122	0.8 mm Cutting Edge (Retrograde)	10" (25.4 cm)
9009-123		12" (30.5 cm)
9009-120	Set Of Three (one each) 9009-121, -122, -123	

Please check with your Scanlan Representative for Firm Sale status. Custom modifications available upon request.
For a complete listing of models visit... www.scanlaninternational.com



Aorta / Vein Punch

SPECIALTY

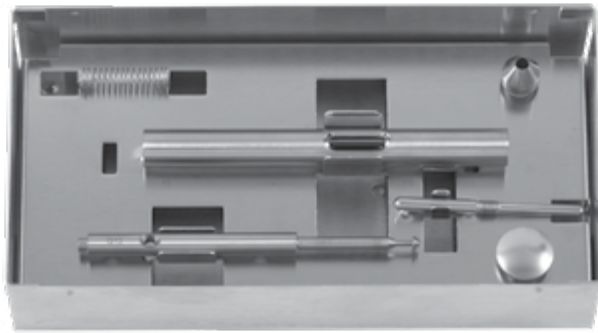

1001-07

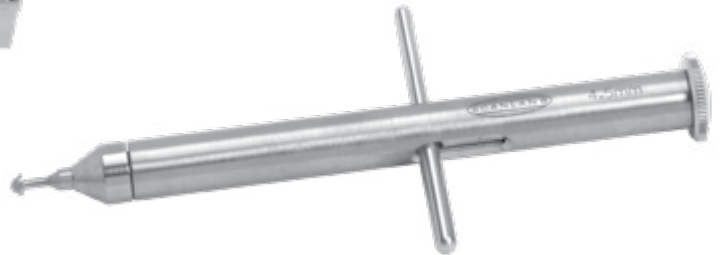

1001-05

SCANLAN®

Aorta / Vein Punch

Cat. No.	Description
1001-04	4.0 mm with Sterilizing Box & Tray
1001-05	4.5 mm with Sterilizing Box & Tray
1001-06	5.5 mm with Sterilizing Box & Tray
1001-07	Sterilizing Box & Tray

Please Note...

Each Scanlan instrument is individually handcrafted to provide the surgeon with the highest quality, longest-lasting, precision instrument possible. Reflecting this unique process, all stated dimensions are approximate.

1001-10

SPECIALTY



SCANLAN®

Cochran Pediatric Retractors

Cat. No.	Description
1001-14	1/4" (6.4 mm) Wide, 6 1/2" (16.5 cm) Long
1001-13	3/8" (9.5 mm) Wide, 6 1/2" (16.5 cm) Long
1001-12	1/2" (12.7 mm) Wide, 6 1/2" (16.5 cm) Long
1001-11	5/8" (15.6 mm) Wide, 6 1/2" (16.5 cm) Long
1001-10	3/4" (19 mm) Wide, 6 1/2" (16.5 cm) long

Please check with your Scanlan Representative for Firm Sale status. Custom modifications available upon request.

For a complete listing of models visit... www.scanlaninternational.com



SPECIALTY

8008-02



SCANLAN®

Ionescu Valve Retractors

Cat. No.	Description	Total Length
8008-02	Double-Ended Leaflet Valve Retractor, Small 6.0 mm And 7.5 mm	8 1/4" (21 cm)

8008-04



SCANLAN®

Ionescu Valve Retractors

Cat. No.	Description	Total Length
8008-04	Double-Ended Valve Retractor, Medium Curved 12 mm And 17 mm	7 1/8" (18.1 cm)

8008-06



SCANLAN®

Ionescu Valve Retractors

Cat. No.	Description	Total Length
8008-06	Double-Ended Valve Retractor, Large Curved 22 mm And 25 mm	9" (23 cm)

Please Note...

Each Scanlan instrument is individually handcrafted to provide the surgeon with the highest quality, longest-lasting, precision instrument possible. Reflecting this unique process, all stated dimensions are approximate.

Hand-Held Retractors – Hooks

8008-10

SPECIALTY



SCANLAN®

Bryant Mitral Hooks

Cat. No.	Description	Total Length
8008-10	Two Semi-Sharp Points	10 3/4" (27.3 cm)
8008-11	One Semi-Sharp Point	

Please check with your Scanlan Representative for Firm Sale status. Custom modifications available upon request.
For a complete listing of models visit... www.scanlaninternational.com



SPECIALTY

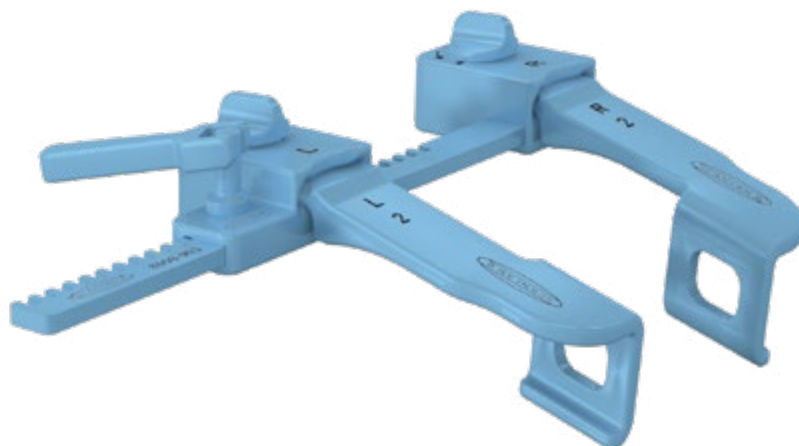

Two Rack Sizes

To allow proper patient fit.

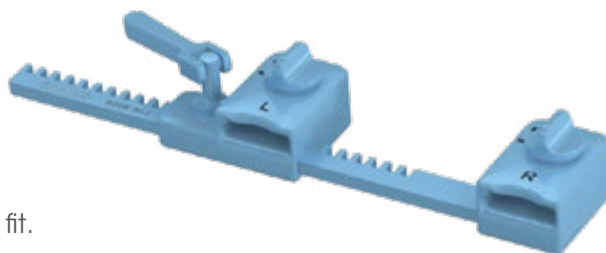

Unique Patented Locking System

for a secure, reliable hold of interchangeable arms.

Interchangeable Retractor Arms

Five unique sizes to ensure proper patient fit.



Scan-Vu®

Radiolucent Arms (Single-Use)



M.D.® Titanium Retractor Arms (Reusable)

Designed for light weight, reliable retraction for open surgical procedures.

Durability

Designed with the highest quality materials for reliability & longevity.

SCANLAN® M.D.® RETRACTOR SYSTEM was developed in cooperation with Francis X. Moga, MD and Ginny Dixon, BSN, RN, CNOR, RNFA

Patent No. 10383613

Please Note...

Each Scanlan instrument is individually handcrafted to provide the surgeon with the highest quality, longest-lasting, precision instrument possible. Reflecting this unique process, all stated dimensions are approximate.

**NEW**

SCANLAN®

M.D.® Retractor System – Size 1Set
8888-901

Cat. No.	Description	Arm Length	Blade Depth	Blade Width
8008-903	M.D.® Titanium Rack, 3" (76 mm) Spread			
8008-911	SCANLAN® Scan-Vu® Radiolucent Single-use Retractor Arms Size 1 Left and Right (1 pair per sterile package)*	1.8" (46 mm)	0.37" (9.5 mm)	0.5" (13 mm)
8008-931R	SCANLAN® M.D.® Titanium Retractor Arm Size 1 Right Arm			
8008-931L	SCANLAN® M.D.® Titanium Retractor Arm Size 1 Left Arm			

**NEW**

SCANLAN®

M.D.® Retractor System – Size 2Set
8888-902

Cat. No.	Description	Length	Blade Depth	Blade Width
8008-903	M.D.® Titanium Rack, 3" (76 mm) Spread			
8008-912	SCANLAN® Scan-Vu® Radiolucent Single-use Retractor Arms Size 2 Left and Right (1 pair per sterile package)*	2.3" (58 mm)	0.63" (16 mm)	0.9" (23 mm)
8008-932R	SCANLAN® M.D.® Titanium Retractor Arm, Size 2 Right Arm			
8008-932L	SCANLAN® M.D.® Titanium Retractor Arm, Size 2 Left Arm			

Please check with your Scanlan Representative for Firm Sale status. Custom modifications available upon request.

For a complete listing of models visit... www.scanlaninternational.com

M.D.® Retractor System

SPECIALTY



NEW

SCANLAN®

M.D.® Retractor System – Size 3

Set
8888-903

Cat. No.	Description	Length	Blade Depth	Blade Width
8008-905	M.D.® Titanium Rack, 5" (127 mm) Spread			
8008-913	SCANLAN® Scan-Vu® Radiolucent Single-use Retractor Arms Size 3 Left and Right (1 pair per sterile package)*	3.0" (76 mm)	0.87" (22 mm)	1.4" (36 mm)
8008-933R	SCANLAN® M.D.® Titanium Retractor Arm, Size 3 Right Arm			
8008-933L	SCANLAN® M.D.® Titanium Retractor Arm, Size 3 Left Arm			



NEW

SCANLAN®

M.D.® Retractor System – Size 4

Set
8888-904

Cat. No.	Description	Length	Blade Depth	Blade Width
8008-905	M.D.® Titanium Rack, 5" (127 mm) Spread			
8008-914	SCANLAN® Scan-Vu® Radiolucent Single-use Retractor Arms, Size 4 Left and Right (1 pair per sterile package)*	3.5" (89 mm)	1.14" (29 mm)	1.8" (45 mm)
8008-934R	SCANLAN® M.D.® Titanium Retractor Arm, Size 4 Right Arm			
8008-934L	SCANLAN® M.D.® Titanium Retractor Arm, Size 4 Left Arm			

Please Note...

Each Scanlan instrument is individually handcrafted to provide the surgeon with the highest quality, longest-lasting, precision instrument possible. Reflecting this unique process, all stated dimensions are approximate.

M.D.® Retractor System

SPECIALTY



NEW

SCANLAN®

M.D.® Retractor System – Size 5

Set
8888-905

Cat. No.	Description	Length	Blade Depth	Blade Width
8008-905	M.D.® Titanium Rack, 5" (127 mm) Spread			
8008-915	SCANLAN® Scan-Vu® Radiolucent Single-use Retractor Arms, Size 5 Left and Right (1 pair per sterile package)*	4.3" (109 mm)	1.38" (35 mm)	2.6" (67 mm)
8008-935R	SCANLAN® M.D.® Titanium Retractor Arm, Size 5 Right Arm			
8008-935L	SCANLAN® M.D.® Titanium Retractor Arm, Size 5 Left Arm			



NEW

SCANLAN®

V.I.P.™ Sterilization Tray

Cat. No.	Description	Dimension
2151-03	Aluminum with Scan-Guard™	17" x 10.5" x 1.88" (43.2 cm x 26.7 cm x 4.8 cm)

New tray designed to accommodate all size variations for quick selection based on patient size.

Please check with your Scanlan Representative for Firm Sale status. Custom modifications available upon request.
For a complete listing of models visit... www.scanlaninternational.com





SCANLAN®
Pediatric Retractor

Cat. No.	Description	Spread	Arms	Blades
8008-43	Retractor With Interchangeable Blades Titanium	52 mm	40 mm	1 Pair: 10 mm Long x 15 mm Deep 1 Pair: 20 mm Long x 15 mm Deep

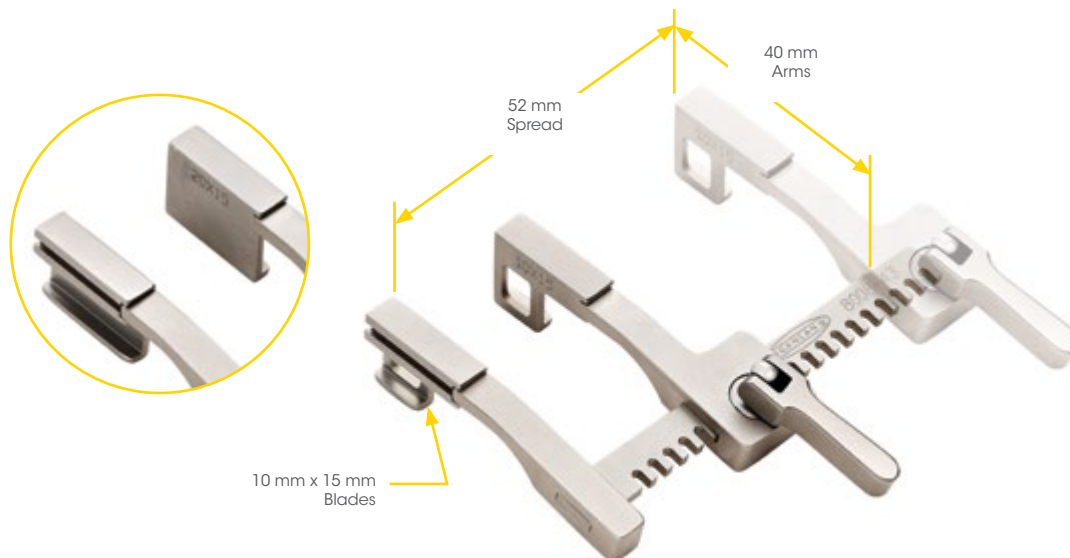

Please Note...

Each Scanlan instrument is individually handcrafted to provide the surgeon with the highest quality, longest-lasting, precision instrument possible. Reflecting this unique process, all stated dimensions are approximate.

Self-Retaining Retractors – Pediatric

8008-41
Instrument is shown approximate size

SPECIALTY

SCANLAN®

Pediatric Finochietto Neonate Retractor

Cat. No.	Description	Spread	Arms	Blades
8008-41	Finochietto Neonate Sternal Retractor Stainless Steel	36 mm	25 mm	7 mm Long x 7 mm Deep

8008-42
Instrument is shown approximate size

SCANLAN®

Pediatric Finochietto Neonate Retractor

Cat. No.	Description	Spread	Arms	Blades
8008-42	Finochietto Neonate Sternal Retractor Titanium	36 mm	25 mm	7 mm Long x 7 mm Deep

Please check with your Scanlan Representative for Firm Sale status. Custom modifications available upon request.
For a complete listing of models visit... www.scanlaninternational.com





SCANLAN®

Bailey Finochietto Sternal Retractors

Cat. No.	Description	Spread	Arms	Blades
8008-45	Bailey Finochietto Sternal Retractor Titanium	80 mm	57 mm	20 mm Long x 20 mm Deep



SCANLAN®

Bailey Finochietto Sternal Retractors

Cat. No.	Description	Spread	Arms	Blades
8008-47	Bailey Finochietto Sternal Retractor Aluminum	80 mm	56 mm	15 mm Long x 15 mm Deep

Please Note...

Each Scanlan instrument is individually handcrafted to provide the surgeon with the highest quality, longest-lasting, precision instrument possible. Reflecting this unique process, all stated dimensions are approximate.

LOFTUS™ ACDF Distractor

8008-81

Instrument is shown approximate size

SPECIALTY

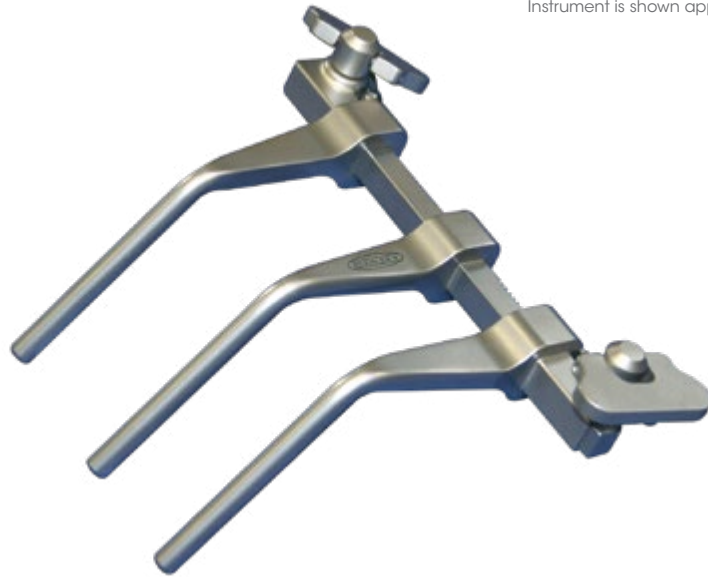

SCANLAN®
LOFTUS™ ACDF Distractor

Cat. No.	Description
8008-81	Loftus™ Two Level ACDF Distractor

Please check with your Scanlan Representative for Firm Sale status. Custom modifications available upon request.
For a complete listing of models visit... www.scanlaninternational.com





SCANLAN®
Olivecrona Double-Ended Dissectors

Cat. No.	Description	Total Length
9009-100		7" (18 cm)
9009-104	With Ligature Guide	7 3/4" (19.7 cm)
9009-106		9 1/2" (24 cm)
9009-110	Without Ligature Guide	9 1/2" (24 cm)



SCANLAN®
Ochsner Double-Ended Dissectors

Cat. No.	Description	Total Length
9009-144	1 mm & 2 mm	7 1/8" (18.1 cm)
9009-146	3 mm & 4 mm	

Please Note...

Each Scanlan instrument is individually handcrafted to provide the surgeon with the highest quality, longest-lasting, precision instrument possible. Reflecting this unique process, all stated dimensions are approximate.

3784-451



SCANLAN®
Jacobson Retrograde Knives / Dissectors with Ball Tip

Cat. No.	Description	Total Length
3784-451	Ball Tip Bayonet Handle	7 1/2" (19 cm)

3784-45



SCANLAN®
Yasargil Micro Arachnoidal Knives

Cat. No.	Description	Total Length
3784-44	Curved Upwards Bayonet Handle	7 1/4" (18.5 cm)
3784-45	Curved Downward Bayonet Handle	

3784-80



Firm Sale - May be available for evaluation

SCANLAN®
Dissector Instrument Tray

Cat. No.	Description	Total Length
3784-80	SCANLAN® V.I.P.™ Metal Sterilization Trays (instruments not included)	9" x 5" x 2" (23 cm x 12.7 cm x 5 cm)

Please check with your Scanlan Representative for Firm Sale status. Custom modifications available upon request.
For a complete listing of models visit... www.scanlaninternational.com



3784-12



SCANLAN®
Yasargil Angled Micro Raspatories

Cat. No.	Description	Total Length
3784-12	Small	7 1/4" (18.5 cm)
3784-11	Large	
3784-09	Angled	

SCANLAN®
Pennfield Dissector

Cat. No.	Description	Total Length
3781-16	Blunt 3 mm Curved Tip	8 3/4" (22 cm)
3781-10	Blunt 6 mm Tip	7 1/4" (18.5 cm)

3784-40



SCANLAN®
Yasargil Micro Raspatories

Cat. No.	Description	Total Length
3784-40	Curved Downward Bayonet Handle	7 1/4" (18.5 cm)
3784-41	Curved Upwards Bayonet Handle	
3784-42	Slightly Curved Bayonet Handle	
3784-13	Strongly Curved Bayonet Handle	
3784-10	Round Handle Painted	

Please Note...
Each Scanlan instrument is individually handcrafted to provide the surgeon with the highest quality, longest-lasting, precision instrument possible. Reflecting this unique process, all stated dimensions are approximate.

3784-43



SCANLAN®
Yasargil Micro Curette

Cat. No.	Description	Total Length
3784-43	Micro Curette Bayonet Style	7 1/4" (18.5 cm)

9009-142



SCANLAN®
Ochsner Angled Delicate Plane Finder Dissector

Cat. No.	Description	Total Length
9009-142	Angled With Ball	7 1/2" (19 cm)

3003-800



SCANLAN®
Titanium Probe

Cat. No.	Description	Total Length
3003-800	Probe	10" (25.4 cm)

Please check with your Scanlan Representative for Firm Sale status. Custom modifications available upon request.
For a complete listing of models visit... www.scanlaninternational.com



Micro Nerve Hooks & Probes

SPECIALTY

3784-32



SCANLAN®
Krayenbuhl Micro Nerve and Vessel Hooks

Cat. No.	Description	Total Length
3784-32	Small	7 1/4" (18.5 cm)
3784-33	Large	

3784-31



SCANLAN®
Krayenbuhl Micro Nerve and Vessel Hooks

Cat. No.	Description	Total Length
3784-30	Pointed Small	7 1/4" (18.5 cm)
3784-31	Pointed Large	

3784-14



SCANLAN®
Jacobson Micro Probes

Cat. No.	Description	Total Length
3784-14	Angled	7 1/4" (18.5 cm)
3784-15	Straight 2-Probes	

Please Note...

Each Scanlan instrument is individually handcrafted to provide the surgeon with the highest quality, longest-lasting, precision instrument possible. Reflecting this unique process, all stated dimensions are approximate.

9009-150
Instrument is shown approximate size

SPECIALTY



SCANLAN®
Ochsner Plaque Remover

Cat. No.	Description	Total Length
9009-150	Curved Fine Tips	6 1/8" (15.5 cm)
9009-152	Straight Fine Tips	

Please check with your Scanlan Representative for Firm Sale status. Custom modifications available upon request.
For a complete listing of models visit... www.scanlaninternational.com



Puskas™ Coronary Instruments – Basic Set

SPECIALTY

SCANLAN®

Puskas™ Coronary Instruments – Basic Set

Basic Set
9999-100

Total Set Includes The Items Listed On Pages 6.30 – 6.31

3003-770



3003-778



3003-810



SCANLAN®

LEGACY Micro Forceps, Titanium

Never Shear™ Dual Guide™ | Round Handle | 10 mm Diameter Knurling

Qty.	Cat. No. 0.5 mm Tips	Cat. No. 1.0 mm Tips	Description	Total Length
1	3003-770		Puskas™ Straight DIAMOND DUST™ Platform Tips	7 1/8" (18.1 cm)
1		3003-778	1 x 2 Micro Teeth	8 1/4" (21 cm)
2	3003-810		Puskas™ Bayonet Style Straight 0.5 mm Straight DIAMOND DUST™ 1 x 2 Micro Teeth	8 3/4" (22 cm)

The Never Shear™ Dual Guide™ design was developed in cooperation with John D. Puskas, MD
DUAL GUIDE™ Patent No. 8,147,512

3003-390



3003-381



SCANLAN®

LEGACY Puskas™ Jacobson Micro Needle Holders, Titanium

8 mm Diameter Extended Knurling | Round Handle

Qty.	Cat. No.	Description	Recommended Suture Size	Total Length
1	3003-390	Straight DIAMOND DUST™ Jaws Streamline Box Lock With Ratchet	5-0 and Smaller	9" (23 cm)
1	3003-381	Straight DIAMOND DUST™ Jaws Regular Box Lock With Ratchet	7-0 and Smaller	8 1/4" (21 cm)

Please Note...

Each Scanlan instrument is individually handcrafted to provide the surgeon with the highest quality, longest-lasting, precision instrument possible. Reflecting this unique process, all stated dimensions are approximate.

Puskas™ Coronary Instruments – Basic Set

Total Set 9999-100 Includes The Items Listed On Pages 6.30 – 6.31

7007-262SC



SPECIALTY

SCANLAN®

Lillehei-Potts Scissors

Ring Handle | Curved Blades

Qty.	Super Cut™ Cat. No.	Description	Total Length
1	7007-262SC	SCANLAN® Puskas™ "Black Knight" Sharp Tips	6 1/2" (16.5 cm)

7007-511



7007-521



SCANLAN®

Puskas™ Premier™ Jacobson Micro Scissors

Bayonet Handle | Nano Blades

Developed in cooperation with John D. Puskas, M.D.

Qty.	Super Cut™ Cat. No.	Description	Total Length
1	7007-511	45° Angled Nano Blades	8" (20 cm)
1	7007-521	Angled Left, V-Neck 125° Angled Nano Blades	

2140-03



SCANLAN®

V.I.P.™ Metal Sterilization Tray

Qty.	Cat. No.	Description	Dimensions	Capacity
1	2140-03	Silver-Gray Color Aluminum	10" x 15" x 1.5" (25.4 x 38 x 3.8 cm)	10-12

Please check with your Scanlan Representative for Firm Sale status. Custom modifications available upon request.

For a complete listing of models visit... www.scanlaninternational.com



Puskas™ Coronary Instruments – Supplemental Set

SPECIALTY

SCANLAN®

Puskas™ Coronary Instruments – Supplemental Set

Designed in cooperation with John D. Puskas, M.D.

Supplemental Set
9999-101

Total Set Includes The Items Listed On Pages 6.32 – 6.33

3003-774



3003-775



3003-776



SCANLAN®

LEGACY Micro Forceps, Titanium

Never Shear™ Dual Guide™ | Round Handle | 10 mm Diameter Knurling

Qty.	Cat. No. 0.5 mm Tips	Description	Total Length
1	3003-774	Puskas™ Straight DIAMOND DUST™ Platform Tips 1 x 2 Micro Teeth	8 1/4" (21 cm)
1	3003-775	Puskas™ Curved DIAMOND DUST™ Platform Tips 1 x 2 Micro Teeth	8 1/4" (21 cm)
1	3003-776	Puskas™ Angled DIAMOND DUST™ Platform Tips 1 x 2 Micro Teeth	8 1/4" (21 cm)

The Never Shear™ Dual Guide™ design was developed in cooperation with John D. Puskas, MD
DUAL GUIDE™ Patent No. 8,147,512

3003-391



SCANLAN®

LEGACY Puskas™ Jacobson Micro Needle Holders, Titanium

8 mm Diameter Extended Knurling | Round Handle

Qty.	Cat. No.	Description	Recommended Suture Size	Total Length
1	3003-391	Straight DIAMOND DUST™ Jaws Regular Box Lock With Ratchet	7-0 and Smaller	9 1/2" (24 cm)

Please Note...

Each Scanlan instrument is individually handcrafted to provide the surgeon with the highest quality, longest-lasting, precision instrument possible. Reflecting this unique process, all stated dimensions are approximate.

Puskas™ Coronary Instruments – Supplemental Set

Total Set 9999-101 Includes The Items Listed On Pages 6.32 – 6.33

SPECIALTY



7007-514



7007-522

SCANLAN®

Puskas™ Premier™ Jacobson Micro Scissors

Flat Handle | Bayonet Style | Nano Blades

Developed in cooperation with John D. Puskas, M.D.

Qty.	Cat. No.	Description	Total Length
1	7007-514	Reversed Handle 45° Angled Left Nano Blades	8" (20 cm)
1	7007-522	Angled Right, V-Neck 125° Angled Nano Blades	

SCANLAN®

V.I.P.™ Metal Sterilization Tray

Qty.	Cat. No.	Description	Dimensions	Capacity
1	2138-03	Silver-Gray Color Aluminum	10" x 10" x 1.5" (25.4 x 25.4 x 3.8 cm)	10-12



Please check with your Scanlan Representative for Firm Sale status. Custom modifications available upon request.
For a complete listing of models visit... www.scanlaninternational.com



Puskas™ Coronary Instruments – IMA Dissection Set

SPECIALTY

SCANLAN®

Puskas™ Coronary Instruments – IMA Dissection Set

IMA Dissection Set
9999-102

Designed in cooperation with John D. Puskas, M.D.

Total Set 9999-102 Includes The Items Listed On Pages 6.34 – 6.35

3003-779



SCANLAN®

LEGACY Micro Forceps, Titanium

Never Shear™ Dual Guide™ | Round Handle | 10 mm Diameter Knurling

Qty.	Cat. No.	Description	Total Length
1	3003-779	Puskas™ Angled DIAMOND DUST™ Platform Tips 1 x 2 Micro Teeth	8 1/4" (21 cm)

The Never Shear™ Dual Guide™ design was developed in cooperation with John D. Puskas, MD
DUAL GUIDE™ Patent No. 8,147,512

7007-506



7007-507



SCANLAN®

Puskas™ Premier™ Jacobson Micro Scissors

Flat Handle | 45° Up Angled | IMA Glide™

Developed in cooperation with John D. Puskas, M.D.

Qty.	Cat. No.	Description	Total Length
1	7007-506	LIMA, Left 90° Angled Fine Blades	8" (20 cm)
1	7007-507	RIMA, Right 90° Angled Fine Blades	

Please Note...

Each Scanlan instrument is individually handcrafted to provide the surgeon with the highest quality, longest-lasting, precision instrument possible. Reflecting this unique process, all stated dimensions are approximate.

Puskas™ Coronary Instruments – IMA Dissection Set

Total Set 9999-102 Includes The Items Listed On Pages 6.34 – 6.35

7007-262SC



SPECIALTY

SCANLAN®

Lillehei-Potts Scissors

Ring Handle | Curved Blades

Qty.	Super Cut™ Cat. No.	Description	Total Length
1	7007-262SC	SCANLAN® Puskas™ "Black Knight" Sharp Tips	6 1/2" (16.5 cm)

SCANLAN®

V.I.P.™ Metal Sterilization Tray

Qty.	Cat. No.	Description	Dimensions	Capacity
1	2138-03	Silver-Gray Color Aluminum	10" x 10" x 1.5" (25.4 x 25.4 x 3.8 cm)	10-12



Please check with your Scanlan Representative for Firm Sale status. Custom modifications available upon request.

For a complete listing of models visit... www.scanlaninternational.com



Dura Closure Set

SPECIALTY

SCANLAN®

Dura Closure Set Designed in cooperation with John D. Puskas, M.D.

Dura Closure Set
9999-109

Total Set Includes The Items Listed On Pages 6.36 – 6.37

9009-360



SCANLAN®

Minimally Invasive Fine Needle Holder – Ring Handle

Qty.	Cat. No.	Description	Total Length
1	9009-360	DIAMOND DUST™ Jaws Curved Sideways (5 mm) With Ratchet	11 1/2" (29 cm)

9009-364



SCANLAN®

Minimally Invasive Jacobson Needle Holder – Spring Style

Qty.	Cat. No.	Description	Total Length
1	9009-364	Round Handle 30° Angled Down DIAMOND DUST™ Curved Jaws	12 1/2" (32 cm)

9009-380



SCANLAN®

Minimally Invasive Chitwood Knot Tier / Pusher – Spring Style

Qty.	Cat. No.	Description	Total Length
1	9009-380	30° Angled Down Fine End For 5.0 Suture or Smaller	11 3/4" (30 cm)

Please Note...

Each Scanlan instrument is individually handcrafted to provide the surgeon with the highest quality, longest-lasting, precision instrument possible. Reflecting this unique process, all stated dimensions are approximate.

Total Set 9999-109 Includes The Items Listed On Pages 6.36 – 6.37

2145-02



SCANLAN®
V.I.P.™ Dura Closure Set Metal Sterilization Tray

Qty.	Cat. No.	Description	Dimensions	Capacity
1	2145-02	SCANLAN® Metal Sterilization Tray, Aluminum, Scan-Guard™ Silicone Inserts, Detachable Lid	10" x 16" x 2.5" (25.4 cm x 40.6 cm x 6.4 cm)	4-5

SCANLAN®

Dura Closure Set (Optional Instruments)

SCANLAN®
SUPER CUT™ Scissors

Developed in cooperation with W. Randolph Chitwood Jr., MD

Cat. No.	Description	Shaft	Working Length	Total Length
9009-716SC	Straight Fine Blades 1 cm Blade Length Blunt Micro Tips Black Platinum Ring Handle	5 mm	6 1/2" (16.5 cm)	10 1/2" (27 cm)
9009-718SC	Curved Fine Blades 1 cm Blade Length Blunt Micro Tips Black Platinum Ring Handle			

SCANLAN®
Micro Forceps

Bayonet Style | Round Handle

Cat. No.	Description	Total Length
3789-20	0.8 mm Straight Tips	10" (25.4 cm)

Please check with your Scanlan Representative for Firm Sale status. Custom modifications available upon request.
 For a complete listing of models visit... www.scanlaninternational.com



Loftus™ Carotid Endarterectomy Set

SPECIALTY

SCANLAN®

Loftus™ Carotid Endarterectomy Set Developed in cooperation with Christopher M. Loftus, M.D.

Loftus Carotid Endarterectomy Set

9999-181

Total Set Includes The Items Listed On Pages 6.38 – 6.43

2002-235



3003-614



4377-08



9009-148



SCANLAN®

Clamps

Qty.	Cat. No.	Description	Total Length
1	2002-235	SCANLAN® Baby Vascular Clamp Cooley Jaws 45° Angled Jaws	5 3/4" (14.6 cm)
1	3003-614	SCANLAN® Micro Clamp, Titanium 60° Angled Jaws 23 mm Jaw Length	4 1/8" (10.5 cm)
1	4377-08	SCANLAN® DeBakey Cooley Forceps Carmalt Jaws with Cross Hatch Tips Right Angled Jaws	7 1/2" (19 cm)
1	9009-148	SCANLAN® Ochsner Forceps 90° Angled Very Fine Serrated Jaws	4 1/2" (11.5 cm)

Please Note...

Each Scanlan instrument is individually handcrafted to provide the surgeon with the highest quality, longest-lasting, precision instrument possible. Reflecting this unique process, all stated dimensions are approximate.

Loftus™ Carotid Endarterectomy Set

Total Set 9999-181 Includes The Items Listed On Pages 6.38 – 6.43

SPECIALTY

3003-04



3003-05



3003-158-8



3003-720



SCANLAN® Forceps

Qty.	Cat. No.	Description	Total Length
1	3003-04	Scanlan® DeBakey Dissecting Forceps Straight DeBakey 2 mm Tips Flat Handle	7 3/4" (19.5 cm)
1	3003-05	Scanlan® DeBakey Dissecting Forceps Straight DeBakey 1 mm Tips Flat Handle	7 3/4" (19.5 cm)
1	3003-158-8	Scanlan® Micro Forceps Straight DIAMOND DUST™ Platform Tips Round Handle	8 1/4" (21 cm)
1	3003-720	Scanlan® Dennis Micro Forceps 1 mm Straight DIAMOND DUST™ Ring Tips Round Handle	7" (18 cm)

3003-234-1



SCANLAN® Needle Holders

Qty.	Cat. No.	Description	Recommended Suture Size	Total Length
1	3003-234-1	SCANLAN® Jacobson Micro Needle Holder Straight Fine DIAMOND DUST™ Jaws Streamline Box Lock With Ratchet	7-0 and Smaller	8 1/2" (21.5 cm)

Please check with your Scanlan Representative for Firm Sale status. Custom modifications available upon request.
For a complete listing of models visit... www.scanlaninternational.com



Loftus™ Carotid Endarterectomy Set

SPECIALTY

Total Set 9999-181 Includes The Items Listed On Pages 6.38 – 6.43

7007-211SC



7007-218-3SC



7007-254SC



7007-320SC



SCANLAN®
Super Cut™ Scissors

Qty.	Cat. No.	Description	Total Length
1	7007-211SC	Stevens Tenotomy Scissors Curved Blades Tenotomy Tips Ring Handle	7" (18 cm)
1	7007-218-3SC	Metzenbaum Scissors Curved Blades 2.5 mm Blunt Tips Ring Handle	7" (18 cm)
1	7007-254SC	Diethrich-Potts Scissors 60° Angled Micro Blades Ring Handle	7" (18 cm)
1	7007-320SC	DeBakey Scissors 45° Angled Blades Blunt Tips Ring Handle	6 1/4" (16 cm)

Please Note...

Each Scanlan instrument is individually handcrafted to provide the surgeon with the highest quality, longest-lasting, precision instrument possible. Reflecting this unique process, all stated dimensions are approximate.

Loftus™ Carotid Endarterectomy Set

Total Set 9999-181 Includes The Items Listed On Pages 6.38 – 6.43

4385-42



SPECIALTY

SCANLAN®

Loftus™ Titanium Bulldog Shunt Clamps

Qty: One of the Following

Cat. No.	Description		Total Length
4385-40	10° Angled	10 Fr. ●	3 3/4" (9.5 cm)
4385-42	25° Angled		
4385-44	45° Angled		
4385-46	60° Angled		
4384-40	10° Angled	12 Fr. ●	
4384-42	25° Angled		
4384-44	45° Angled		
4384-46	60° Angled		
4383-40	10° Angled	14 Fr. ●	
4383-42	25° Angled		
4383-44	45° Angled		
4383-46	60° Angled		

(Set includes one of the following shunt clamps. Please indicate choice when placing order.)

9009-144



9009-146



SCANLAN®

Ochsner Double-Ended Dissectors

Qty.	Cat. No.	Description	Total Length
1	9009-144	1 mm & 2 mm	7 1/8" (18.1 cm)
1	9009-146	3 mm & 4 mm	

Please check with your Scanlan Representative for Firm Sale status. Custom modifications available upon request.
For a complete listing of models visit... www.scanlaninternational.com



Loftus™ Carotid Endarterectomy Set

SPECIALTY

Total Set 9999-181 Includes The Items Listed On Pages 6.38 – 6.43

1001-506



SCANLAN®
VASCU-STAT® Applier

Qty.	Cat. No.	Description	Total Length
1	1001-506	VASCU-STAT® Applier Straight	8 1/2" (21.5 cm)

1001-550



SCANLAN®
VASCU-STAT® Plus

Qty.	Cat. No.	Description
1	1001-550	VASCU-STAT® Plus Midi Straight

1001-76

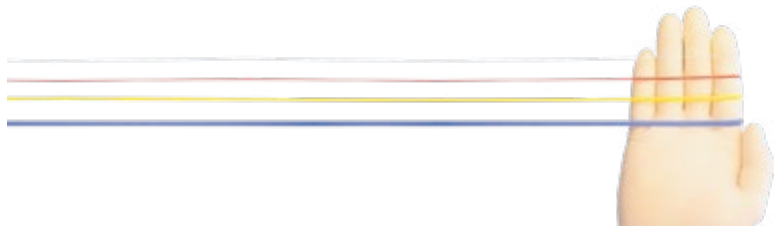

SCANLAN®
SURG-I-LOOP®

Qty.	Cat. No.	Description	Total Length
1	1001-76	SURG-I-LOOP® Red, Maxi	16 1/2" (42 cm)

Please Note...

Each Scanlan instrument is individually handcrafted to provide the surgeon with the highest quality, longest-lasting, precision instrument possible. Reflecting this unique process, all stated dimensions are approximate.

Loftus™ Carotid Endarterectomy Set

Total Set 9999-181 Includes The Items Listed On Pages 6.38 – 6.43

2081-23

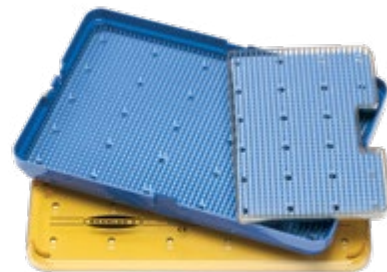

SPECIALTY

SCANLAN®

V.I.P.™ Sterilization Tray, Plastic

Cat. No.	Description	Dimensions	Capacity
2081-23	Plastic Clasps Additional 1/2 Tray Insert Scan-Guard™ Silicone Mats	15" x 10" x 1.5" (38 x 25.4 cm x 3.8 cm)	15+

2142-03



SCANLAN®

V.I.P.™ Metal Sterilization Tray

Cat. No.	Description	Dimensions	Capacity
2142-03	Silver-gray color, Scan-Guard™ silicone insert across full width of base, additional tray insert	10" x 15" x 2.6" (25.4 cm x 38 cm x 6.6 cm)	18+

Please indicate choice of sterilization tray at time of order.

Please check with your Scanlan Representative for Firm Sale status. Custom modifications available upon request.
For a complete listing of models visit... www.scanlaninternational.com



Ochsner Endarterectomy Set

SPECIALTY

SCANLAN®

Ochsner Endarterectomy Set Developed in cooperation with John L. Ochsner, M.D.
Ochsner Endarterectomy Set
9999-192

Total Set Includes The Items Listed On Pages 6.44 – 6.45

SCANLAN® Clamps

Qty.	Cat. No.	Description	Total Length
1	9009-148	SCANLAN® Ochsner Forceps 90° Angled Very Fine Serrated Jaws	4 1/2" (11.5 cm)



SCANLAN® Forceps

Qty.	Cat. No.	Description	Total Length
1	4004-37	SCANLAN® DeBaKey Needle Pulling Tissue Forceps 2 mm Straight Carbon-inlay Tips Flat Handle (Gold Handle)	7 1/2" (19 cm)
1	4004-224	SCANLAN® Dennis Micro Forceps 1 mm Straight DIAMOND DUST™ Ring Tips Counterbalanced	8 1/4" (21 cm)



SCANLAN® Ochsner Dissectors

Qty.	Cat. No.	Description	Total Length
1	9009-142	Angled Delicate Plane Finder Dissector, Angled With Ball	7 1/2" (19 cm)
1	9009-144	Double-Ended Dissectors 1 mm & 2 mm	7 1/8" (18.1 cm)
1	9009-146	Double-Ended Dissectors 3 mm & 4 mm	



Please Note...
Each Scanlan instrument is individually handcrafted to provide the surgeon with the highest quality, longest-lasting, precision instrument possible. Reflecting this unique process, all stated dimensions are approximate.

Ochsner Endarterectomy Set

Total Set 9999-192 Includes The Items Listed On Pages 6.44 – 6.45

9009-150



9009-152



SPECIALTY

SCANLAN®
Ochsner Plaque Remover

Qty.	Cat. No.	Description	Total Length
1	9009-150	Curved Fine Tips Ring Handle	6 1/8" 15.5 cm)
1	9009-152	Straight Fine Tips Ring Handle	

SCANLAN®
V.I.P.™ Metal Sterilization Tray

Qty.	Cat. No.	Description	Dimensions	Capacity
1	2138-03	Silver-Gray Color Aluminum Scan-Guard™ Silicone Inserts	10" x 10" x 1.5" (25.4 x 25.4 x 3.8 cm)	10-12



Please check with your Scanlan Representative for Firm Sale status. Custom modifications available upon request.
For a complete listing of models visit... www.scanlaninternational.com



EC / IC Bypass Instrument Set

SPECIALTY

SCANLAN®

EC / IC Bypass Instrument Total Set

Total Set
9999-166

Total set includes three subsets (9999-162, 9999-163, 9999-164) and are listed on pages 6.46 – 6.51
EC / IC Bypass Instrument Set may be purchased as a set or as individual components.

SCANLAN®

EC / IC Bypass Instrument Subset #1

Total Set
9999-162

3003-154-3



3003-156-3



3003-164



4004-03-3A



SCANLAN®

Forceps

Round Handle

Qty.	Cat. No.	Description	Total Length
1	3003-154-3	SCANLAN® Micro Suture Tying Forceps, Titanium 0.3 mm Straight Platform Gerald Type Taper DIAMOND DUST™ Tips	6" (15 cm)
1	3003-156-3	SCANLAN® Micro Suture Tying Forceps, Titanium 0.3 mm Curved Platform Gerald Type Taper DIAMOND DUST™ Tips	
1	3003-164	SCANLAN® Micro Forceps, Titanium 1 mm Straight DIAMOND DUST™ Ring Tips	
1	4004-03-3A	SCANLAN® Micro Suture Tying Forceps, Stainless Steel 0.3 mm Angled 45° Angled DIAMOND DUST™	5 1/2" (14 cm)

Please Note...

Each Scanlan instrument is individually handcrafted to provide the surgeon with the highest quality, longest-lasting, precision instrument possible. Reflecting this unique process, all stated dimensions are approximate.

EC / IC Bypass Instrument Set

SPECIALTY

Total set 9999-166 includes three subsets (9999-162, 9999-163, 9999-164) and are listed on pages 6.46 – 6.51
EC / IC Bypass Instrument Set may be purchased as a set or as individual components.

6006-56-3



SCANLAN®
Needle Holders
Round Handle

Qty.	Cat. No.	Description	Recommended Suture Size	Total Length
1	6006-56-3	SCANLAN® Castroviejo Micro Needle Holder, Stainless Steel 0.3 mm Tapered Curved DIAMOND DUST™ Jaws Regular Box Lock Without Ratchet	8-0 and Smaller	5 3/4" (14.5 cm)

7007-140



SCANLAN®
Jacobson Vannas Micro Scissors
Flat Handle

Qty.	Cat. No.	Description	Total Length
1	7007-140	SCANLAN® Jacobson Vannas Micro Scissors 45° Angled Micro Fine Blades Stainless Steel	7" (18 cm)

Optional SCANLAN® V.I.P.™ Sterilization Trays

Cat. No.	Description	Dimensions	Capacity
2138-03	Silver-gray color Scan-Guard™ Silicone Inserts	10" x 10" x 1.5" (25.4 x 25.4 x 3.8 cm)	8-10
2140-03	Silver-gray color Scan-Guard™ Silicone Inserts	10" x 15" x 1.5" (25.4 x 38 x 3.8 cm)	10-12
2141-03	Silver-gray color, base with accessory compartment Scan-Guard™ Silicone Inserts	10" x 15" x 2.6" (25.4 x 38 x 6.6 cm)	15+

Please check with your Scanlan Representative for Firm Sale status. Custom modifications available upon request.
For a complete listing of models visit... www.scanlaninternational.com



EC / IC Bypass Instrument Set

SPECIALTY

SCANLAN®

EC / IC Bypass Instrument Total Set

Total Set
9999-166

Total set includes three subsets (9999-162, 9999-163, 9999-164) and are listed on pages 6.46 – 6.51
EC / IC Bypass Instrument Set may be purchased as a set or as individual components.

SCANLAN®

EC / IC Bypass Instrument Subset #2

Total Set
9999-163

Set Includes The Items Listed On Pages 6.48 – 6.49

3003-158-3



3003-159-3



3003-164



4004-97-3A



SCANLAN®

Forceps

Round Handle

Qty.	Cat. No.	Description	Total Length
1	3003-158-3	SCANLAN® Micro Forceps, Titanium Gerald Type Taper 0.3 mm Straight DIAMOND DUST™ Platform Tips	7 1/4" (18.5 cm)
1	3003-159-3	SCANLAN® Micro Forceps, Titanium Gerald Type Taper 0.3 mm Curved DIAMOND DUST™ Platform Tips	7 1/4" (18.5 cm)
1	3003-164	SCANLAN® Micro Forceps, Titanium 1 mm Straight DIAMOND DUST™ Ring Tips	6" (15 cm)
1	4004-97-3A	SCANLAN® Micro Forceps, Stainless Steel 0.3 mm Angled DIAMOND DUST™ 45° Angled	5 1/2" (14 cm)

Please Note...

Each Scanlan instrument is individually handcrafted to provide the surgeon with the highest quality, longest-lasting, precision instrument possible. Reflecting this unique process, all stated dimensions are approximate.

EC / IC Bypass Instrument Set

Total set 9999-166 includes three subsets (9999-162, 9999-163, 9999-164) and are listed on pages 6.46 – 6.51
EC / IC Bypass Instrument Set may be purchased as a set or as individual components.

3003-177-3



SPECIALTY

SCANLAN®

Jacobson Micro Needle Holders

Round Handle

Qty.	Cat. No.	Description	Recommended Suture Size	Total Length
1	3003-177-3	SCANLAN® Jacobson Micro Needle Holder, Titanium 0.3 mm Tapered Curved DIAMOND DUST™ Jaws Regular Box Lock Without Ratchet	8-0 and Smaller	7 1/4" (18.5 cm)

7007-140



SCANLAN®

Scissors

Flat Handle

Qty.	Cat. No.	Description	Total Length
1	7007-140	SCANLAN® Jacobson Vannas Micro Scissors 45° Angled Micro Fine Blades Spring Style Flat Handle	7" (18 cm)

Please check with your Scanlan Representative for Firm Sale status. Custom modifications available upon request.

For a complete listing of models visit... www.scanlaninternational.com



EC / IC Bypass Instrument Set

SPECIALTY

SCANLAN®

EC / IC Bypass Instrument Total Set

Total Set
9999-166

Total set includes three subsets (9999-162, 9999-163, 9999-164) and are listed on pages 6.46 – 6.51
EC / IC Bypass Instrument Set may be purchased as a set or as individual components.

SCANLAN®

EC / IC Bypass Instrument Subset #3

Total Set
9999-164

Set Includes The Items Listed On Pages 6.50 – 6.51



SCANLAN®

Forceps

Bayonet Style | Flat Handle

Qty.	Cat. No.	Description	Total Length
1	3003-842	SCANLAN® Micro Forceps, Titanium 0.3 mm Straight DIAMOND DUST™ Tips	8 3/4" (22 cm)
1	3003-841	SCANLAN® Micro Forceps, Titanium 0.3 mm 45° Angle DIAMOND DUST™ Tips	
1	3003-840	SCANLAN® Micro Forceps, Titanium 0.3 mm Curved Up DIAMOND DUST™ Tips	
1	3003-851	SCANLAN® Micro Forceps, Titanium 1 mm DIAMOND DUST™ Ring Tips	

Please Note...

Each Scanlan instrument is individually handcrafted to provide the surgeon with the highest quality, longest-lasting, precision instrument possible. Reflecting this unique process, all stated dimensions are approximate.

EC / IC Bypass Instrument Set

SPECIALTY

Total set 9999-166 includes three subsets (9999-162, 9999-163, 9999-164) and are listed on pages 6.46 – 6.51
EC / IC Bypass Instrument Set may be purchased as a set or as individual components.

3789-14-3



SCANLAN®
Micro Needle Holders
Bayonet Style | Round Handle

Qty.	Cat. No.	Description	Recommended Suture Size	Total Length
1	3789-14-3	SCANLAN® Micro Needle Holder, Stainless Steel 0.3 mm Curved Up DIAMOND DUST™ Jaws Regular Box Lock Without Ratchet	8-0 and Smaller	9" (23 cm)

3788-02



SCANLAN®
Micro Scissors
Bayonet Style | Flat Handle

Qty.	Cat. No.	Description	Total Length
1	3788-02	SCANLAN® Micro Scissors Vannas 45° Angled Up On Flat Micro Fine Blades	8 3/4" (22 cm)

Optional SCANLAN® V.I.P.™ Sterilization Trays

Cat. No.	Description	Dimensions	Capacity
2138-03	Silver-gray color Scan-Guard™ Silicone Inserts	10" x 10" x 1.5" (25.4 x 25.4 x 3.8 cm)	8-10
2140-03	Silver-gray color Scan-Guard™ Silicone Inserts	10" x 15" x 1.5" (25.4 x 38 x 3.8 cm)	10-12
2141-03	Silver-gray color, base with accessory compartment, Scan-Guard™ Silicone Inserts	10" x 15" x 2.6" (25.4 x 38 x 6.6 cm)	15+

Please check with your Scanlan Representative for Firm Sale status. Custom modifications available upon request.
For a complete listing of models visit... www.scanlaninternational.com



Samson™ Phlebectomy Set – Plastic V.I.P.™ Sterilization Tray

SPECIALTY

SCANLAN®

Samson™ Phlebectomy Set

Set
9999-150

Set Includes The Items Listed On Pages 6.52 – 6.53

8008-230



8008-236



SCANLAN®

Samson™ Phlebectomy Hooks, Black Platinum Handle

Designed in cooperation with Russell H. Samson, M.D.

Qty.	Cat. No.	Description	Total Length
1	8008-230	Right Short	4 1/4" (11 cm)
1	8008-236	Right Long	5 1/2" (14 cm)

5005-86



5005-88



SCANLAN®

Delicate Mosquito Forceps

Qty.	Cat. No.	Description	Total Length
1	5005-86	Very Fine Curved Jaws	5" (12.7 cm)
1	5005-88	Curved Jaws 1 x 2 Teeth	

5005-82



SCANLAN®

Vascular Mosquito Forceps

Qty.	Cat. No.	Description	Total Length
1	5005-82	Curved Jaws Sharp Grasping Serrations	5" (12.7 cm)

Please Note...

Each Scanlan instrument is individually handcrafted to provide the surgeon with the highest quality, longest-lasting, precision instrument possible. Reflecting this unique process, all stated dimensions are approximate.

Samson™ Phlebectomy Set – Plastic V.I.P.™ Sterilization Tray

Total set 9999-150 includes The Items Listed On Pages 6.52 – 6.53

7007-210SC



SPECIALTY

SCANLAN®

Stevens Tenotomy Scissors

Ring Handle

Qty.	Super Cut™ Cat. No.	Description	Total Length
1	7007-210SC	Curved Blades Tenotomy Tips	4 5/8" (11.7 cm)

2081-11

SCANLAN®

V.I.P.™ Plastic Sterilization Tray

Qty.	Cat. No.	Description	Dimensions	Capacity
1	2081-11	Scan-Guard™ Silicone Mats	10" x 6" x 0.7" (25.4 cm x 15 cm x 1.8 cm)	6-10

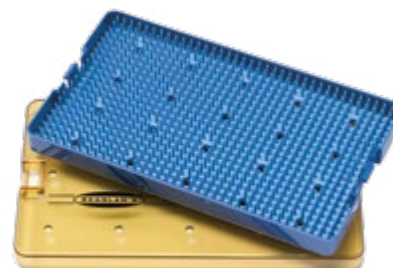

Samson™ Phlebectomy Set – Optional Products

SCANLAN®

Samson™ Phlebectomy Hooks, Black Platinum Handle

Designed in cooperation with Russell H. Samson, M.D.

Qty.	Cat. No.	Description	Total Length
1	8008-232	Left Short	4 1/4" (11 cm)

SCANLAN®

Phlebectomy Haemostat

Qty.	Cat. No.	Description	Total Length
1	5005-80	90° Angled Very Fine Jaws Sharp Grasping Serrations	4 1/2" (11.5 cm)

SCANLAN®

Surgical Skin Markers

Cat. No.	Description
1001-710	Gentian Violet Regular Tip

Please check with your Scanlan Representative for Firm Sale status. Custom modifications available upon request.
For a complete listing of models visit... www.scanlaninternational.com



Samson™ Phlebectomy Set – Metal V.I.P.™ Sterilization Tray

SPECIALTY

SCANLAN®
Samson™ Phlebectomy Set
 Set
 9999-151

Set Includes The Items Listed On Pages 6.54 – 6.55

8008-230



8008-236



SCANLAN®
Samson™ Phlebectomy Hooks, Black Platinum Handle

Designed in cooperation with Russell H. Samson, M.D.

Qty.	Cat. No.	Description	Total Length
1	8008-230	Right Short	4 1/4" (11 cm)
1	8008-236	Right Long	5 1/2" (14 cm)

5005-86



5005-88



SCANLAN®
Delicate Mosquito Forceps

Qty.	Cat. No.	Description	Total Length
1	5005-86	Very Fine Curved Jaws	5" (12.7 cm)
1	5005-88	Curved Jaws 1 x 2 Teeth	

5005-82

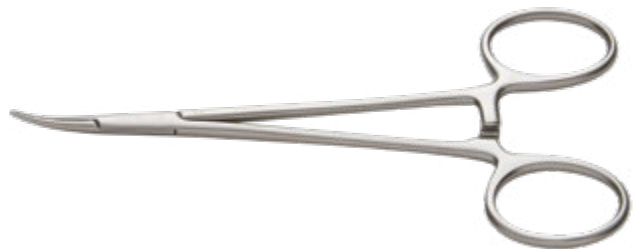

SCANLAN®
Vascular Mosquito Forceps

Qty.	Cat. No.	Description	Total Length
1	5005-82	Curved Jaws Sharp Grasping Serrations	5" (12.7 cm)

Please Note...

Each Scanlan instrument is individually handcrafted to provide the surgeon with the highest quality, longest-lasting, precision instrument possible. Reflecting this unique process, all stated dimensions are approximate.

Samson™ Phlebectomy Set – Metal V.I.P.™ Sterilization Tray

Total set 9999-151 includes The Items Listed On Pages 6.54 – 6.55

SPECIALTY

7007-210SC



2138-03

SCANLAN®

Stevens Tenotomy Scissors

Ring Handle

Qty.	Super Cut™ Cat. No.	Description	Total Length
1	7007-210SC	Curved Blades Tenotomy Tips	4 5/8" (11.7 cm)

SCANLAN®

V.I.P.™ Metal Sterilization Tray

Qty.	Cat. No.	Description	Dimensions	Capacity
1	2138-03	Silver-Gray Color Aluminum Scan-Guard™ Silicone Inserts	10" x 10" x 1.5" (25.4 x 25.4 x 3.8 cm)	10-12



Samson™ Phlebectomy Set – Optional Products

SCANLAN®

Samson™ Phlebectomy Hooks, Black Platinum Handle

Designed in cooperation with Russell H. Samson, M.D.

Qty.	Cat. No.	Description	Total Length
1	8008-232	Left Short	4 1/4" (11 cm)

SCANLAN®

Phlebectomy Haemostat

Qty.	Cat. No.	Description	Total Length
1	5005-80	90° Angled Very Fine Jaws Sharp Grasping Serrations	4 1/2" (11.5 cm)

SCANLAN®

Surgical Skin Markers

Cat. No.	Description
1001-710	Gentian Violet Regular Tip

Please check with your Scanlan Representative for Firm Sale status. Custom modifications available upon request.
For a complete listing of models visit... www.scanlaninternational.com



SPECIALTY

