

TITANIUM MICRO VASCULAR CLAMPS

Micro Clamps2.1
 Castaneda Clamps.....2.5
 Profunda.....2.6
 Lambert-Kay2.7

TITANIUM MEDIUM VASCULAR CLAMPS

Castaneda Clamps.....2.8
 Peripheral Clamp.....2.9
 Beck Infant Aorta Clamp.....2.10
 Subramanian Infant Aorta Clamp.....2.10
 Dennis Multi-Purpose Clamps2.11
 Aorta Clamps.....2.12
 DeBakey Vascular Clamps2.13

TITANIUM LARGE VASCULAR CLAMPS

DeBakey Vascular Clamps2.14
 Satinsky Clamps.....2.15
 Aorta Clamps.....2.16

TITANIUM SPECIALTY

SCANLAN® Loftus™ Titanium Bulldog Shunt Clamps.....2.17

MICRO VASCULAR

SCANLAN® Baby Vascular.....2.18

HAEMOSTATS

Ochsner Forceps / Phlebectomy Haemostat2.44
 Bailey2.45
 Mosquito Forceps2.46
 Vascular Forceps2.47
 Adson Forceps2.49
 Bengolea Forceps.....2.50
 Crafoord Artery Forceps2.51
 DeBakey Cooley Forceps2.52

SPECIALTY

MacDougall Clamp2.54
 Prostatectomy Clamp.....2.55
 Allis Intestinal Clamp2.55
 Vasectomy Forceps2.56

MEDIUM VASCULAR

SCANLAN® Vascular Clamps2.23
 Hausmann Clamps2.24
 Dennis Clamps2.25
 SCANLAN® Multi-Purpose.....2.34
 Dennis Aortic Anastomosis Clamps.....2.35
 Lambert / Kay Anastomosis Clamps.....2.35
 Dennis Multi-Purpose2.36

LARGE VASCULAR

SCANLAN® Anastomosis2.37
 Tangential Occlusion Clamps2.38
 Satinsky Occlusion Clamps.....2.39
 Hunter-Satinsky Aortic Clamps2.40
 SCANLAN® Aortic Aneurysm Clamps.....2.41
 Pollock Aortic Clamps2.43



Clamp Modifications

Modification	Description
904	Angle jaws/tips
904A	Angle and cut down jaws/tips
905	Cut down jaws/tips
907	Angled shanks - down
907B	Angled shanks - up
911	Cut down shanks
917	Bailey modification (30°, 60°, 90°)
923	Satin finish instrument
924	Tension modification
928	Modify to left-handed instrument (ring style)
928A	Modify to left-handed instrument (spring style)
929	Special etching
971	Lengthen instrument
973	Shorten instrument



3003-73 with modifications **904** and **907**

3003-73



9909-912-13 with modifications **907B**

9909-912-13

5005-51



5005-51 with modifications **917** (90°)

Please Note...

Each Scanlan instrument is individually handcrafted to provide the surgeon with the highest quality, longest-lasting, precision instrument possible. Reflecting this unique process, all stated dimensions are approximate.









3003-620
Instrument is shown approximate size

Titanium CLAMPS



SCANLAN®
Micro Clamps
DeBakey Jaws

Instrument jaws are shown
approximate size

	Cat. No.	Description	Total Length
	3003-616	6 mm Jaws Slightly Angled Shanks 14 mm Jaw Length	4 1/8" (10.5 cm)
	3003-618	6 mm Spoon Jaws Straight Shanks 14 mm Jaw Length	
	3003-620	9 mm Jaws Slightly Angled Shanks 16 mm Jaw Length	
	3003-636	6 mm Jaws Slightly Angled Shanks 22 mm Jaw Length	4 3/8" (11.2 cm)
	3003-637	9 mm Jaws Slightly Angled Shanks 20 mm Jaw Length	
	3003-638	6 mm Spoon Jaws Straight Shanks 26 mm Jaw Length	4 5/8" (11.8 cm)

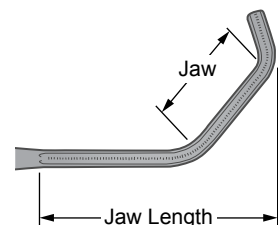

Please Note...
Each Scanlan instrument is individually handcrafted to provide the surgeon with the highest quality, longest-lasting, precision instrument possible.
Reflecting this unique process, all stated dimensions are approximate.





Please check with your Scanlan Representative for Firm Sale status. Custom modifications available upon request.
For a complete listing of models visit... www.scanlaninternational.com





SCANLAN®
Micro Clamps
Angled DeBakey Jaws

Instrument jaws are shown approximate size

	Cat. No.	Description	Total Length
	3003-613	45° Angled Jaws 25 mm Jaw Length	4 1/4" (11 cm)
	3003-633	45° Angled Jaws 30 mm Jaw Length	4 1/2" (11.5 cm)
	3003-614	60° Angled Jaws 23 mm Jaw Length	4 1/8" (10.5 cm)
	3003-634	60° Angled Jaws 30 mm Jaw Length	4 1/4" (11 cm)

Please Note...

Each Scanlan instrument is individually handcrafted to provide the surgeon with the highest quality, longest-lasting, precision instrument possible. Reflecting this unique process, all stated dimensions are approximate.

3003-610

Instrument is shown approximate size

Titanium CLAMPS

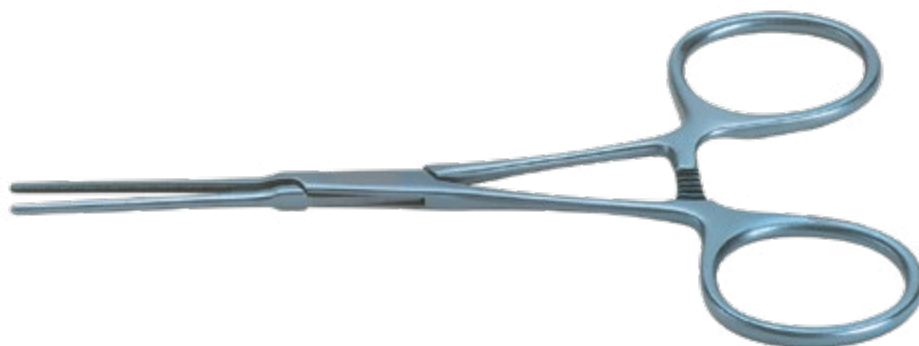

SCANLAN®
Micro Clamps
 Angled DeBakey Jaws

Instrument jaws are shown approximate size

		Cat. No.	Description	Total Length
		3003-610	Straight Shanks 30 mm Jaw Length	4 3/4" (12 cm)
		3003-611	Slightly Angled Shanks 30 mm Jaw Length	
		3003-612	Angled Shanks 22 mm Jaw Length	4 1/4" (11 cm)
		3003-632	Angled Shanks 30 mm Jaw Length	4 5/8" (11.8 cm)

Please check with your Scanlan Representative for Firm Sale status. Custom modifications available upon request.
 For a complete listing of models visit... www.scanlaninternational.com



3003-628





Instrument is shown approximate size



SCANLAN®

Micro Kitzmiller Clamps

Angled DeBakey Jaws

	Cat. No.	Description	Total Length
	3003-628	Left Angled Jaws 23 mm Jaw Length	4 1/4" (11 cm)
			
	3003-630	Right Angled Jaws 23 mm Jaw Length	
			

Please Note...

Each Scanlan instrument is individually handcrafted to provide the surgeon with the highest quality, longest-lasting, precision instrument possible. Reflecting this unique process, all stated dimensions are approximate.

3003-52

Instrument is shown approximate size

Titanium CLAMPS



SCANLAN®
Castaneda Clamps
Cooley Jaws

Instrument jaws are shown approximate size

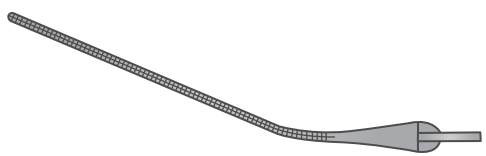
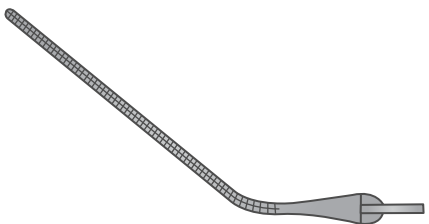
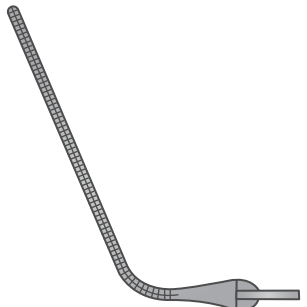
	Cat. No.	Description	Total Length
	3003-52	30° Angled Jaws	5 1/4" (13.5 cm)
	3003-54	50° Angled Jaws	
	3003-56	70° Angled Jaws	4 3/4" (12 cm)

Please check with your Scanlan Representative for Firm Sale status. Custom modifications available upon request.
For a complete listing of models visit... www.scanlaninternational.com



3003-617

Instrument is shown approximate size



SCANLAN®
Micro Clamps

Instrument jaws are shown approximate size

	Cat. No.	Description	Total Length
	<p>NEW 3003-617</p>	<p>Profunda Clamp Angled Shanks DeBakey Jaws</p>	<p>5 1/8" (13 cm)</p>

Please Note...

Each Scanlan instrument is individually handcrafted to provide the surgeon with the highest quality, longest-lasting, precision instrument possible. Reflecting this unique process, all stated dimensions are approximate.

3003-59
 Instrument is shown approximate size

Titanium CLAMPS



SCANLAN®
Micro Clamp

Instrument jaws are shown approximate size

	Cat. No.	Description	Total Length
	NEW 3003-59	Lambert-Kay Angled Shanks Cooley Jaws	4 1/4" (11 cm)

Please check with your Scanlan Representative for Firm Sale status. Custom modifications available upon request.
 For a complete listing of models visit... www.scanlaninternational.com



3003-46

Instrument is shown approximate size

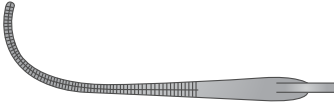
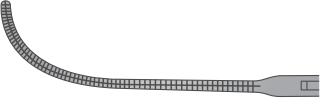

SCANLAN®
Castaneda Clamps
Cooley Jaws

Instrument jaws are shown approximate size	Cat. No.	Description	Total Length
	3003-47	Curved Jaws	6" (15 cm)
	3003-46	Slightly Curved Jaws	

3003-67



SCANLAN®
Castaneda Clamps
Double-Angled Cooley Jaws

Instrument jaws are shown approximate size	Cat. No.	Description	Total Length
	3003-67	Carotid Clamp	7 1/2" (19 cm)

Please Note...

Each Scanlan instrument is individually handcrafted to provide the surgeon with the highest quality, longest-lasting, precision instrument possible. Reflecting this unique process, all stated dimensions are approximate.

3003-64

Instrument is shown approximate size

Titanium CLAMPS



SCANLAN®
Peripheral Clamp
DeBakey Jaws

Instrument jaws are shown approximate size

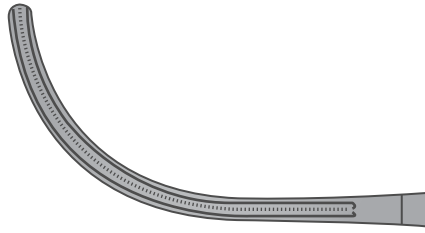
	Cat. No.	Description	Total Length
	3003-64	Peripheral Clamp Curved DeBakey Jaws	6 1/4" (16 cm)

Please check with your Scanlan Representative for Firm Sale status. Custom modifications available upon request.
For a complete listing of models visit... www.scanlaninternational.com



Titanium CLAMPS

3003-66

Instrument is shown approximate size



SCANLAN®
Beck Infant Aorta Clamp
DeBakey Jaws

Instrument jaws are shown approximate size

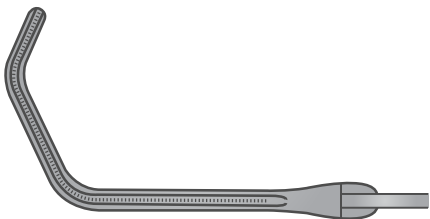
	Cat. No.	Description	Total Length
	3003-66	Beck Infant Aorta Clamp DeBakey Jaws	6 1/2" (16.5 cm)

3003-68

Instrument is shown approximate size

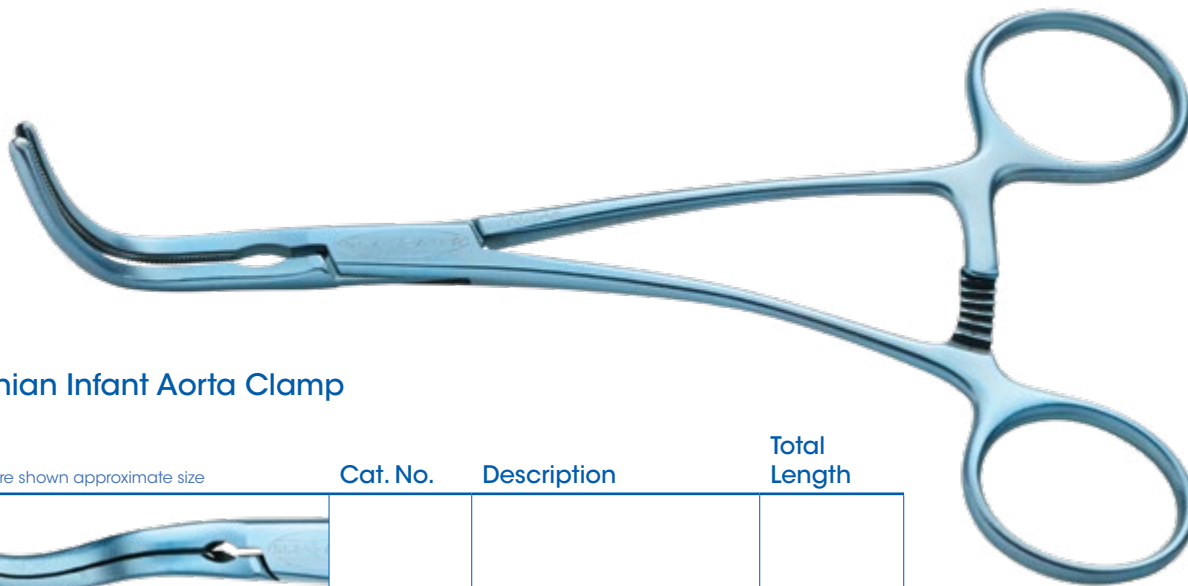

SCANLAN®
Subramanian Infant Aorta Clamp
DeBakey Jaws

Instrument jaws are shown approximate size

	Cat. No.	Description	Total Length
 <p>Top View</p>	3003-68	Subramanian Infant Aorta Clamp DeBakey Jaws	6 1/4" (16 cm)

Please Note...

Each Scanlan instrument is individually handcrafted to provide the surgeon with the highest quality, longest-lasting, precision instrument possible. Reflecting this unique process, all stated dimensions are approximate.



Medium Vascular | Dennis Multi-Purpose

3003-282

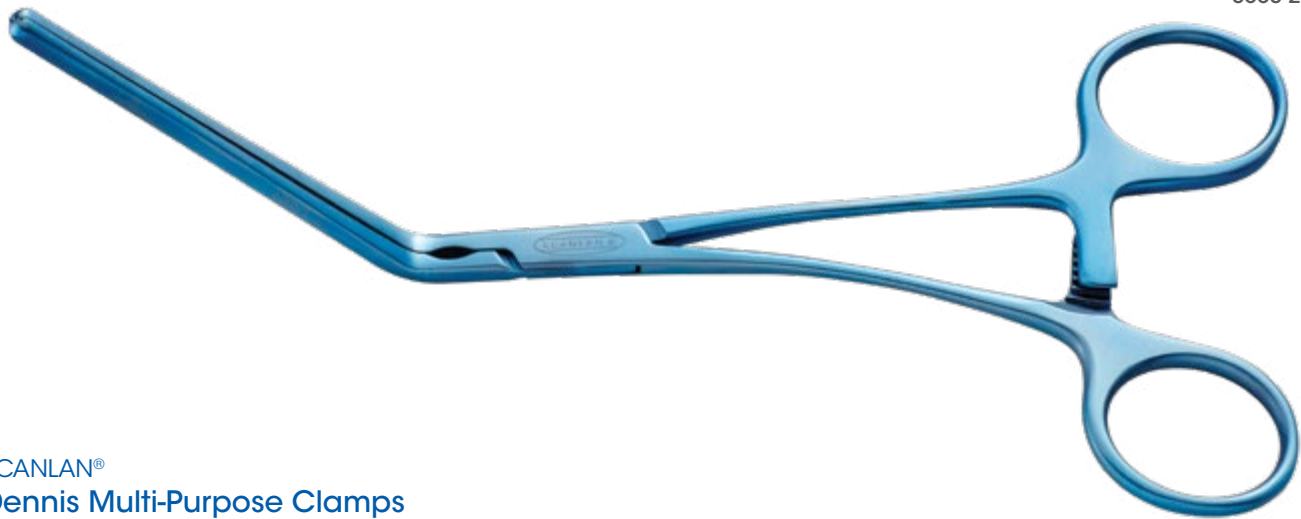
Titanium CLAMPS



SCANLAN®
Dennis Multi-Purpose Clamps
DeBakey Jaws

	Cat. No.	Description	Total Length
	3003-280	Straight 2 x 3 DeBakey Jaws 8.5 cm Jaw Length	8 1/2" (21.5 cm)
	3003-282	45° Angled 2 x 3 DeBakey Jaws 8 cm Jaw Length	8" (20 cm)
	3003-286	90° Angled 2 x 3 DeBakey Jaws 6 cm Jaw Length	5 1/2" (14 cm)

Please check with your Scanlan Representative for Firm Sale status. Custom modifications available upon request.
For a complete listing of models visit... www.scanlaninternational.com





SCANLAN®
Aorta Clamps
DeBakey Jaws

Instrument jaws are shown approximate size

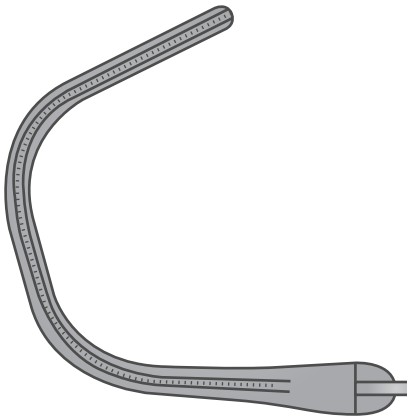
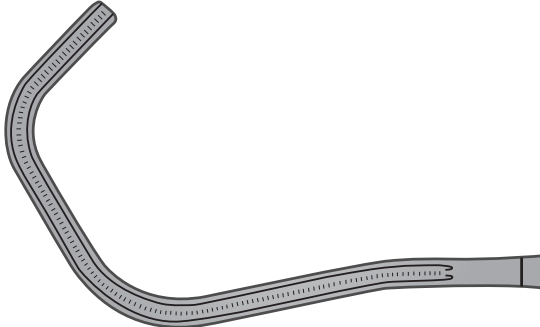
	Cat. No.	Description	Total Length
	3003-70	Kay Aorta Clamp 3 cm Jaws	8" (20 cm)
	3003-72	Lambert-Kay Aorta Clamp 3 cm Jaws	

Please Note...

Each Scanlan instrument is individually handcrafted to provide the surgeon with the highest quality, longest-lasting, precision instrument possible. Reflecting this unique process, all stated dimensions are approximate.

3003-69

Titanium CLAMPS



SCANLAN®
DeBakey Vascular Clamps
DeBakey Jaws

Instrument jaws are shown approximate size

	Cat. No.	Description	Total Length
	3003-69	7.5 cm Jaws	7 3/8" (18.8 cm)

Please check with your Scanlan Representative for Firm Sale status. Custom modifications available upon request.
For a complete listing of models visit... www.scanlaninternational.com





SCANLAN®

DeBakey Vascular Clamps

DeBakey Jaws

Instrument jaws are shown approximate size

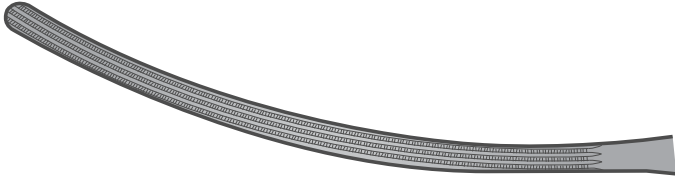
	Cat. No.	Description	Total Length
	3003-79	8 cm Jaws 2x3 DeBakey Wide Jaw	11" (28 cm)

Please Note...

Each Scanlan instrument is individually handcrafted to provide the surgeon with the highest quality, longest-lasting, precision instrument possible. Reflecting this unique process, all stated dimensions are approximate.

3003-86

Titanium CLAMPS

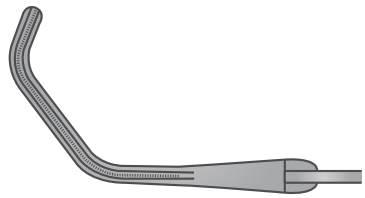
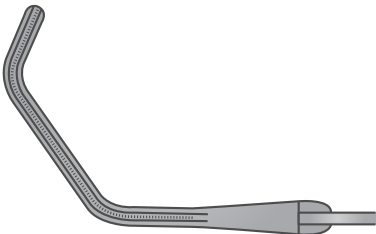
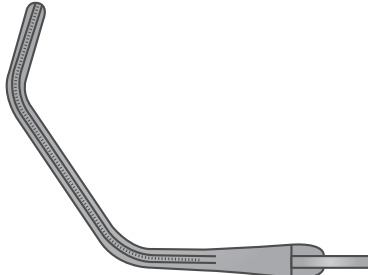
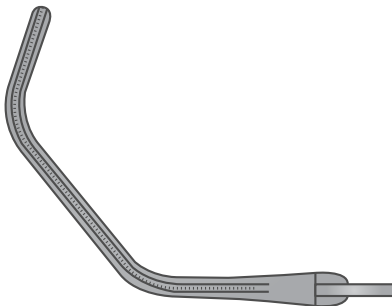

SCANLAN®
Satinsky Clamps
DeBaKey Jaws

	Cat. No.	Description	Total Length
	3003-84	2 cm Jaws	10" (25.4 cm)
	3003-82	2.5 cm Jaws	
	3003-80	3 cm Jaws	
	3003-86	3.5 cm Jaws	

Please check with your Scanlan Representative for Firm Sale status. Custom modifications available upon request.
For a complete listing of models visit... www.scanlaninternational.com



Titanium CLAMPS

3003-88

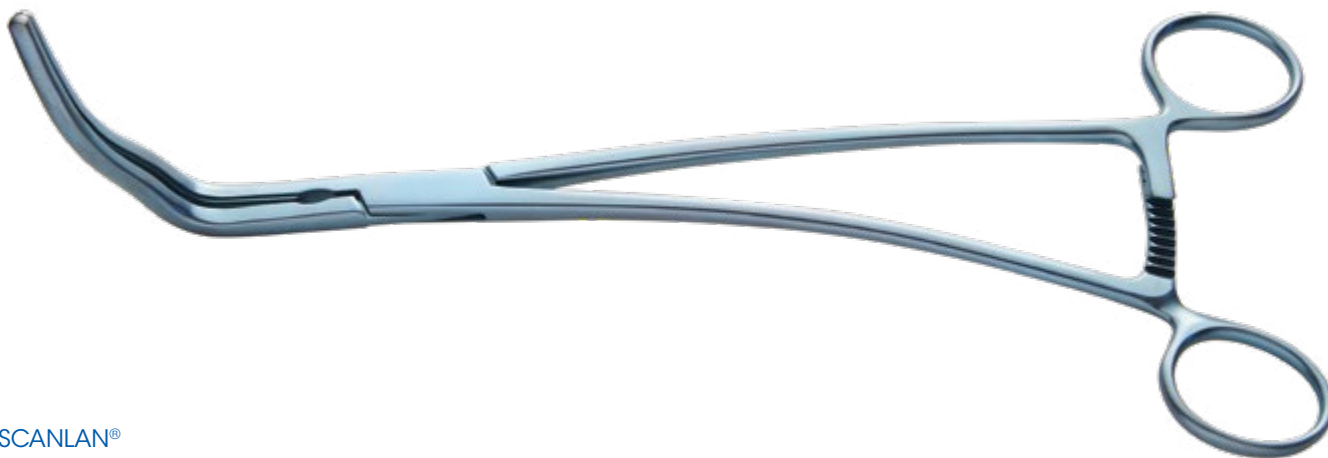

SCANLAN®
Aorta Clamps

	Cat. No.	Description	Total Length
	3003-74	5.5 cm Curved Cooley Jaws	9 3/4" (24.8 cm)
	3003-88	7 cm 2x3 DeBakey Jaws	10 1/2" (27 cm)

Please Note...

Each Scanlan instrument is individually handcrafted to provide the surgeon with the highest quality, longest-lasting, precision instrument possible. Reflecting this unique process, all stated dimensions are approximate.

4385-42



Titanium CLAMPS

SCANLAN®
Loftus™ Titanium Bulldog Shunt Clamps

	Cat. No.	Description	Total Length
	4385-40	10° Angled 10 Fr.	3 3/4" (9.5 cm)
	4385-42	25° Angled 10 Fr.	
	4385-44	45° Angled 10 Fr.	
	4385-46	60° Angled 10 Fr.	
	4384-40	10° Angled 12 Fr.	
	4384-42	25° Angled 12 Fr.	
	4384-44	45° Angled 12 Fr.	
	4384-46	60° Angled 12 Fr.	
	4383-40	10° Angled 14 Fr.	
	4383-42	25° Angled 14 Fr.	
	4383-44	45° Angled 14 Fr.	
	4383-46	60° Angled 14 Fr.	

Please check with your Scanlan Representative for Firm Sale status. Custom modifications available upon request.
For a complete listing of models visit... www.scanlaninternational.com





SCANLAN®

Baby Vascular Clamps

Cooley Jaws

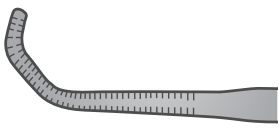
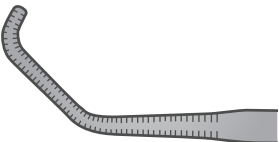
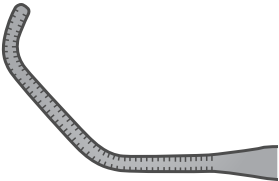
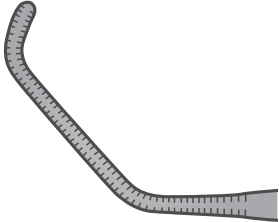
	Cat. No.	Description	Total Length
	2002-246	8 mm Jaws	5 3/4" (14.5 cm)
	2002-244	12 mm Jaws	
	2002-242	16 mm Jaws	5 1/4" (13.5 cm)
	2002-240	20 mm Jaws	

Please Note...

Each Scanlan instrument is individually handcrafted to provide the surgeon with the highest quality, longest-lasting, precision instrument possible. Reflecting this unique process, all stated dimensions are approximate.

2002-234

Instrument is shown approximate size



Stainless Steel CLAMPS

SCANLAN®
Baby Vascular Clamps
 Cooley Jaws

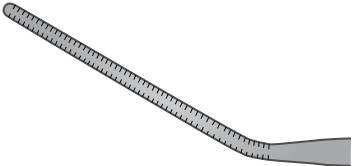
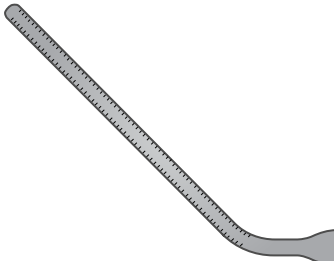
Instrument jaws are shown approximate size	Cat. No.	Description	Total Length
	2002-232	4 cm Straight Jaws	6" (15 cm)
	2002-234	25° Angled Jaws	5 3/4" (14.5 cm)
	2002-235	45° Angled Jaws	

Please check with your Scanlan Representative for Firm Sale status. Custom modifications available upon request.
 For a complete listing of models visit... www.scanlaninternational.com



2002-236

Instrument is shown approximate size



SCANLAN®

Baby Vascular Clamps

Cooley Jaws

Instrument jaws are shown approximate size

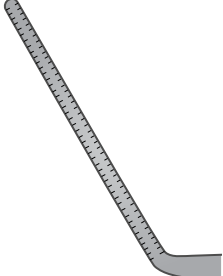
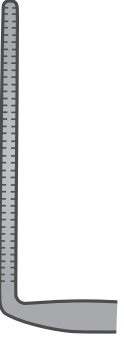
	Cat. No.	Description	Total Length
	2002-236	60° Angled Jaws	5 1/4" (13.5 cm)
	2002-238	90° Angled Jaws	

Please Note...

Each Scanlan instrument is individually handcrafted to provide the surgeon with the highest quality, longest-lasting, precision instrument possible. Reflecting this unique process, all stated dimensions are approximate.

2002-231



Instrument is shown approximate size



Stainless Steel CLAMPS

SCANLAN®
Baby Vascular Clamps
Cooley Jaws

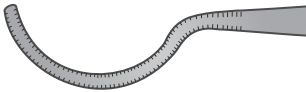
Instrument jaws are shown approximate size

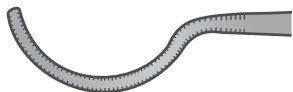
	Cat. No.	Description	Total Length
	2002-229	Small Spoon Jaws Straight Shanks	5 3/4" (14.5 cm)
	2002-230	Spoon Jaws Straight Shanks	6" (15 cm)
	2002-231	Profunda Clamp Angled Shanks	5 1/2" (14 cm)

Please check with your Scanlan Representative for Firm Sale status. Custom modifications available upon request.
 For a complete listing of models visit... www.scanlaninternational.com



2002-248

Instrument is shown approximate size



SCANLAN®

Baby Vascular Clamps

Cooley Jaws

	Cat. No.	Description	Total Length
	2002-248	Kitzmiller, Left Angled Jaws	5 1/4" (13.5 cm)
	2002-250	Kitzmiller, Right Angled Jaws	

Please Note...

Each Scanlan instrument is individually handcrafted to provide the surgeon with the highest quality, longest-lasting, precision instrument possible. Reflecting this unique process, all stated dimensions are approximate.

2002-128



Stainless Steel CLAMPS

SCANLAN®
Vascular Clamps
 DeBakey Jaws

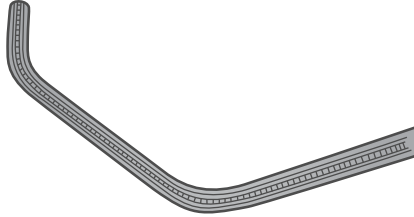
	Cat. No.	Description	Total Length
	2002-128	6.5 cm Straight Jaws Straight Shanks	8 1/2" (21.5 cm)
	2002-134	30 mm Jaws Angled Shanks	8" (20 cm)

Please check with your Scanlan Representative for Firm Sale status. Custom modifications available upon request.
 For a complete listing of models visit... www.scanlaninternational.com



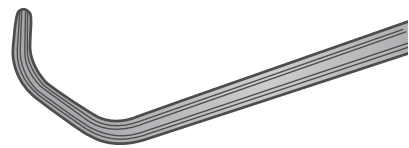
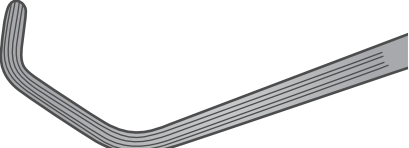

SCANLAN®
Vascular Clamps
 Hausmann Jaws

	Cat. No.	Description	Total Length
	2002-186	12 mm Jaws Straight Shanks	8" (20 cm)
	2002-184	18 mm Jaws Straight Shanks	

Please Note...

Each Scanlan instrument is individually handcrafted to provide the surgeon with the highest quality, longest-lasting, precision instrument possible. Reflecting this unique process, all stated dimensions are approximate.

Medium Vascular | Dennis Carotid

2002-90
Instrument is shown approximate size



Stainless Steel CLAMPS

SCANLAN®
Dennis Carotid Clamps
DeBakey Jaws

	Cat. No.	Description	Total Length
	2002-90	1.5 cm Carotid Clamp	7" (18 cm)

Medium Vascular | Dennis Peripheral

2002-78

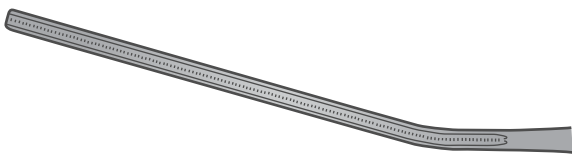

SCANLAN®
Dennis Peripheral Vascular Clamps
DeBakey Jaws

	Cat. No.	Description	Total Length
	2002-78	6 cm DeBakey Jaws	8" (20 cm)

Please check with your Scanlan Representative for Firm Sale status. Custom modifications available upon request.
For a complete listing of models visit... www.scanlaninternational.com





SCANLAN®

Dennis Anastomosis Clamps

Cooley Jaws

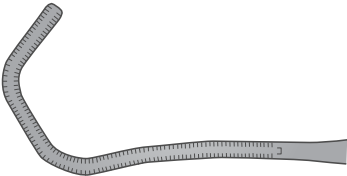
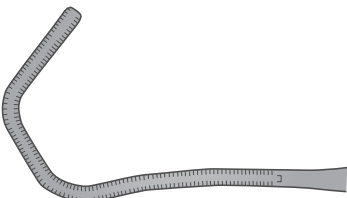
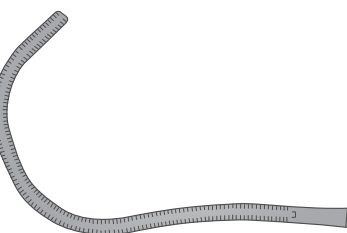
	Cat. No.	Description	Total Length
	2002-92	1 cm Jaws	6 1/2" (16.5 cm)
	2002-94	1.5 cm Jaws	6 3/4" (17 cm)
	2002-96	2 cm Jaws	

Please Note...

Each Scanlan instrument is individually handcrafted to provide the surgeon with the highest quality, longest-lasting, precision instrument possible. Reflecting this unique process, all stated dimensions are approximate.

Medium Vascular | Dennis Anastomosis

2002-62
Instrument is shown approximate size



Stainless Steel CLAMPS

SCANLAN®
Dennis Anastomosis Clamps
DeBaKey Jaws

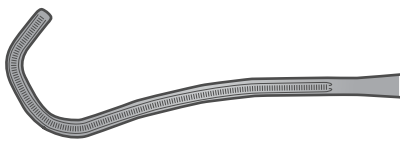
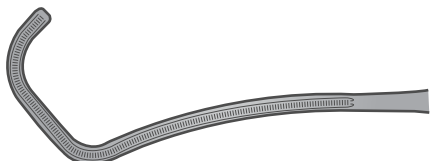
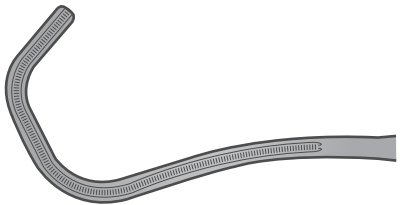
	Cat. No.	Description	Total Length
	2002-62	1 cm Jaws	7" (18 cm)
	2002-64	1.5 cm Jaws	
	2002-70	1.5 cm Jaws	

Please check with your Scanlan Representative for Firm Sale status. Custom modifications available upon request.
For a complete listing of models visit... www.scanlaninternational.com



2002-72

Instrument is shown approximate size



SCANLAN®

Dennis Anastomosis Clamps

DeBaKey Jaws

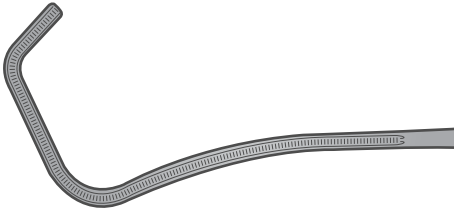
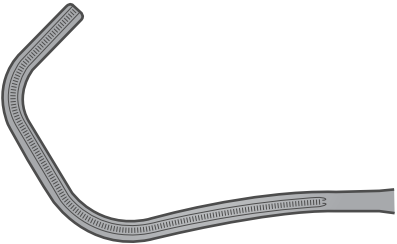
	Cat. No.	Description	Total Length
	2002-66	2 cm Jaws	7" (18 cm)
	2002-72	2 cm Jaws	

Please Note...

Each Scanlan instrument is individually handcrafted to provide the surgeon with the highest quality, longest-lasting, precision instrument possible. Reflecting this unique process, all stated dimensions are approximate.

Medium Vascular | Dennis Anastomosis

2002-100
Instrument is shown approximate size

Stainless Steel CLAMPS

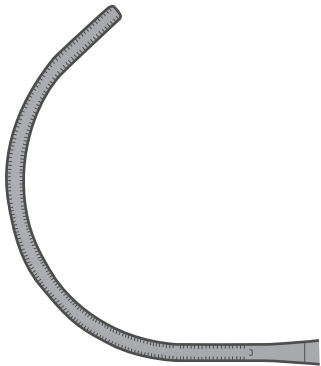
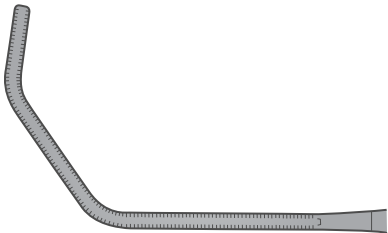

SCANLAN®
Dennis Anastomosis Clamps
Cooley Jaws

	Cat. No.	Description	Total Length
	2002-100	Semi-Circle Jaws	6 3/4" (17 cm)
	2002-106	2 cm Jaws	7" (18 cm)

Please check with your Scanlan Representative for Firm Sale status. Custom modifications available upon request.
For a complete listing of models visit... www.scanlaninternational.com



2002-110

Instrument is shown approximate size



SCANLAN®

Dennis Multi-Purpose Clamps

Cooley Jaws

	Cat. No.	Description	Total Length
	2002-110	3 cm Angled Jaws	6 1/4" (16 cm)

Please Note...

Each Scanlan instrument is individually handcrafted to provide the surgeon with the highest quality, longest-lasting, precision instrument possible. Reflecting this unique process, all stated dimensions are approximate.

Medium Vascular | Dennis Multi-Purpose



2002-286

Instrument is shown approximate size



Stainless Steel CLAMPS

SCANLAN®
Dennis Multi-Purpose Clamps
 DeBaKey Jaws

	Cat. No.	Description	Total Length
	2002-280	Straight 2 x 3 DeBaKey Jaws 8.5 cm Jaw Length	8 1/2" (21.5 cm)
	2002-282	45° Angled 2 x 3 DeBaKey Jaws 8 cm Jaw Length	8" (20 cm)
	2002-286	90° Angled 2 x 3 DeBaKey Jaws 6 cm Jaw Length	5 1/2" (14 cm)

Please check with your Scanlan Representative for Firm Sale status. Custom modifications available upon request.
 For a complete listing of models visit... www.scanlaninternational.com





SCANLAN®

Dennis Multi-Purpose Clamps

Angled DeBakey Jaws

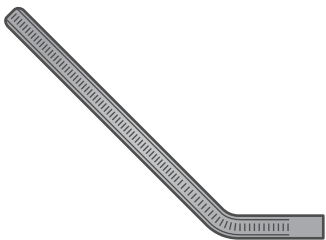
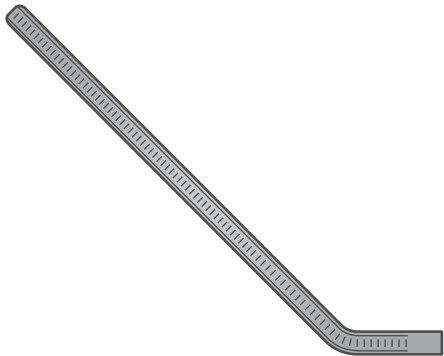
	Cat. No.	Description	Total Length
	2002-82	4 cm 45° Angled Jaws	6 1/4" (16 cm)
	2002-80	6 cm 45° Angled Jaws	7 1/4" (18.5 cm)

Please Note...

Each Scanlan instrument is individually handcrafted to provide the surgeon with the highest quality, longest-lasting, precision instrument possible. Reflecting this unique process, all stated dimensions are approximate.

Medium Vascular | Dennis Multi-Purpose

2002-88

Stainless Steel CLAMPS

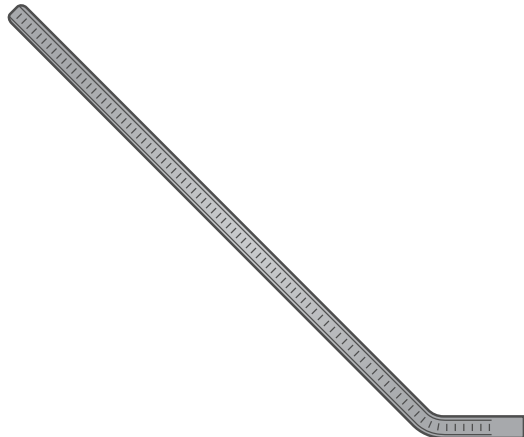
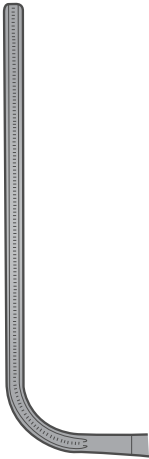

SCANLAN®
Dennis Multi-Purpose Clamps
 Angled DeBakey Jaws

	Cat. No.	Description	Total Length
	2002-88	8 cm 45° Angled Jaws	8" (20 cm)
	2002-86	6 cm 90° Angled Jaws	5 1/2" (14 cm)

Please check with your Scanlan Representative for Firm Sale status. Custom modifications available upon request.
 For a complete listing of models visit... www.scanlaninternational.com



Stainless Steel CLAMPS

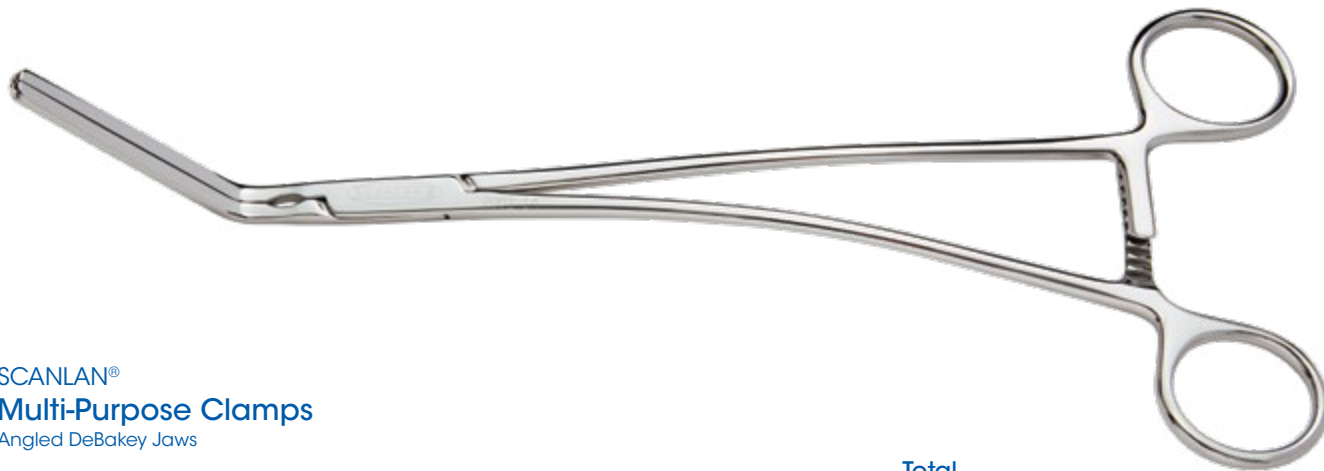

SCANLAN®
Multi-Purpose Clamps
Angled DeBakey Jaws

Instrument jaws are shown approximate size

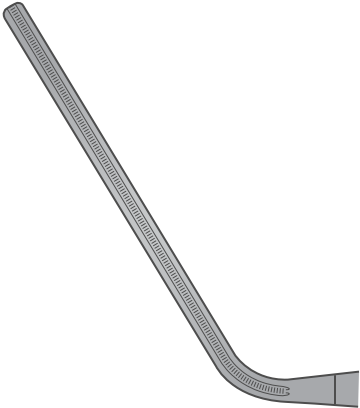
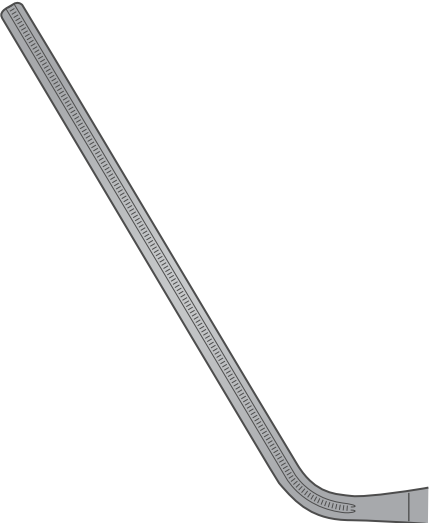
	Cat. No.	Description	Total Length
	2002-14	6 cm 60° Angled Jaws	9" (23 cm)
	2002-16	7.5 cm 60° Angled Jaws	

Please Note...

Each Scanlan instrument is individually handcrafted to provide the surgeon with the highest quality, longest-lasting, precision instrument possible. Reflecting this unique process, all stated dimensions are approximate.

2002-76

Stainless Steel CLAMPS

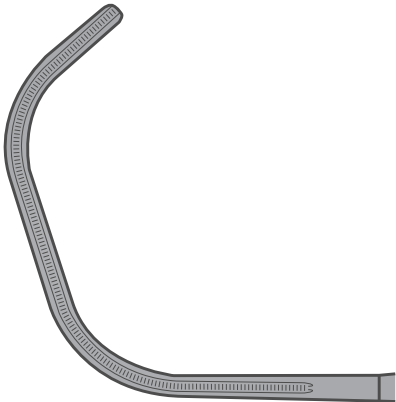

SCANLAN®
Dennis Aortic Anastomosis Clamps
 DeBaKey Jaws

	Cat. No.	Description	Total Length
	2002-76	Aorta Clamp 3 cm Jaws	7" (18 cm)

SCANLAN®
Lambert-Kay Anastomosis Clamps
 DeBaKey Jaws

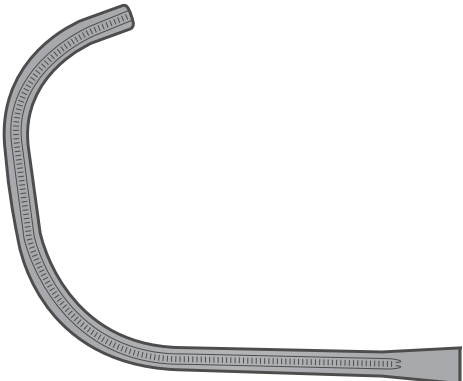
	Cat. No.	Description	Total Length
	2002-42	Aorta Clamp 3 cm Jaws	8 3/4" (22 cm)

Please check with your Scanlan Representative for Firm Sale status. Custom modifications available upon request.
 For a complete listing of models visit... www.scanlaninternational.com



Stainless Steel CLAMPS



SCANLAN®
Dennis Multi-Purpose Clamps
Straight Jaws

Cat. No.	Description	Total Length
2002-112	4 cm Cooley Jaws, Angled Shanks	6 3/4" (17 cm)
2002-23	8 cm DeBakey Jaws	10 1/4" (26 cm)
2002-113	8.5 cm Cooley Jaws, Angled Shanks	8 1/2" (21.5 cm)
2002-13	8.5 cm DeBakey Jaws	8 1/2" (21.5 cm)
2002-43	10.5 cm DeBakey Jaws	11 3/8" (28.8 cm)
2002-51	11 cm DeBakey Jaws	12 1/2" (32 cm)
2002-33	13.5 cm DeBakey Jaws	13" (33 cm)

Please Note...

Each Scanlan instrument is individually handcrafted to provide the surgeon with the highest quality, longest-lasting, precision instrument possible. Reflecting this unique process, all stated dimensions are approximate.

Large Vascular | SCANLAN® Anastomosis

2002-38



Stainless Steel CLAMPS

SCANLAN®
Anastomosis Clamps
 DeBaKey Jaws

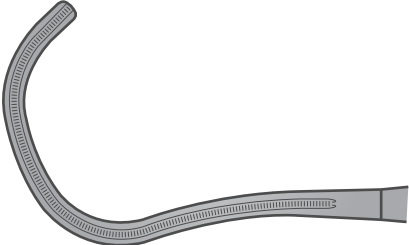
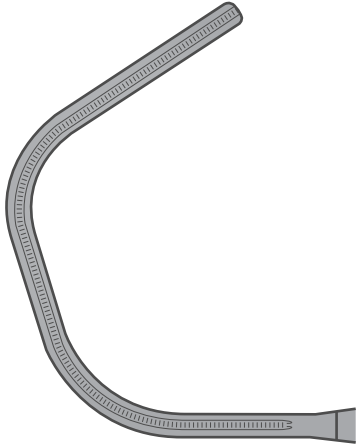
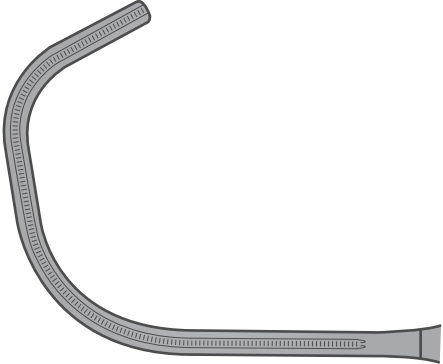
	Cat. No.	Description	Total Length
	2002-52	2 cm Jaws	
	2002-38	3.5 cm Jaws	8 1/2" (21.5 cm)
	2002-40		10 1/4" (26 cm)

Please check with your Scanlan Representative for Firm Sale status. Custom modifications available upon request.
 For a complete listing of models visit... www.scanlaninternational.com



Stainless Steel CLAMPS



SCANLAN®
Tangential Occlusion Clamps
 DeBaKey Jaws

Instrument jaws are shown approximate size

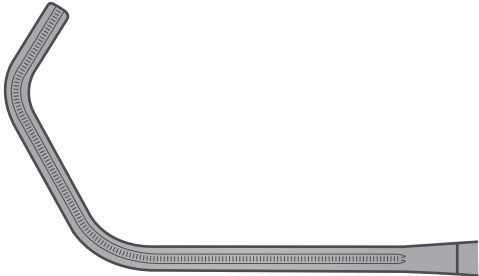
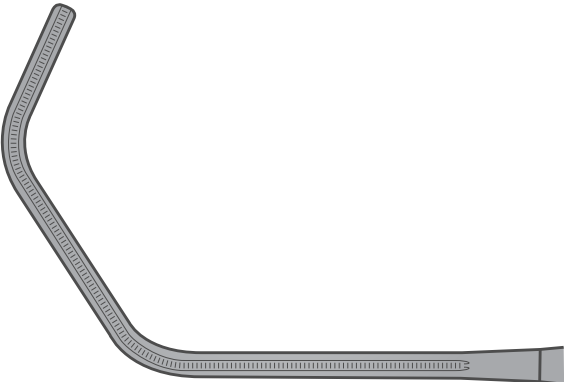
	Cat. No.	Description	Total Length
	2002-28	2.5 cm Jaws	9" (23 cm)
	2002-30	3.4 cm Jaws	9 1/4" (23.5 cm)

Please Note...

Each Scanlan instrument is individually handcrafted to provide the surgeon with the highest quality, longest-lasting, precision instrument possible. Reflecting this unique process, all stated dimensions are approximate.

Large Vascular | Satinsky Occlusion

2002-34



Stainless Steel CLAMPS

SCANLAN®
Satinsky Occlusion Clamps
DeBaKey Jaws

Instrument jaws are shown approximate size

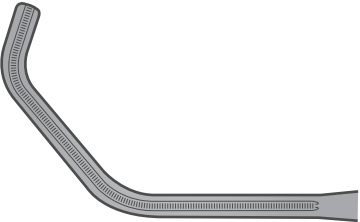
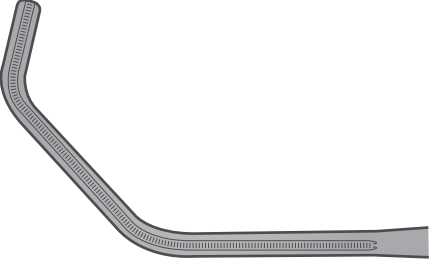
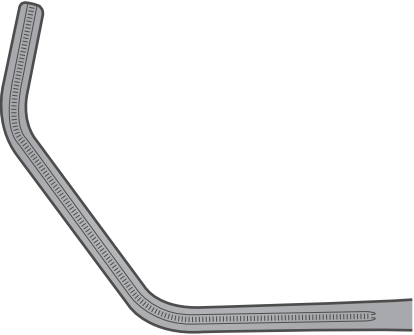
	Cat. No.	Description	Total Length
	2002-34	2.3 cm Jaws	8 1/2" (21.5 cm)
	2002-32	2.7 cm Jaws	
	2002-36	3.5 cm Jaws	

Please check with your Scanlan Representative for Firm Sale status. Custom modifications available upon request.
 For a complete listing of models visit... www.scanlaninternational.com



Stainless Steel CLAMPS

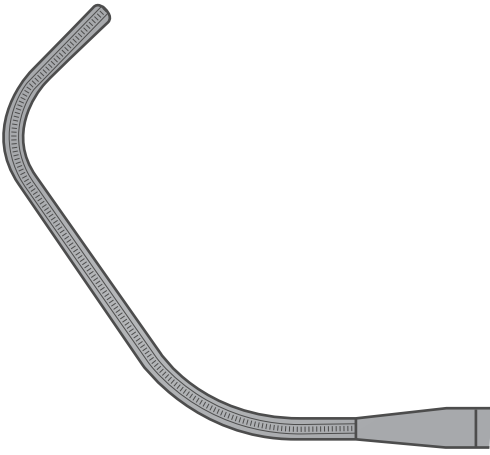
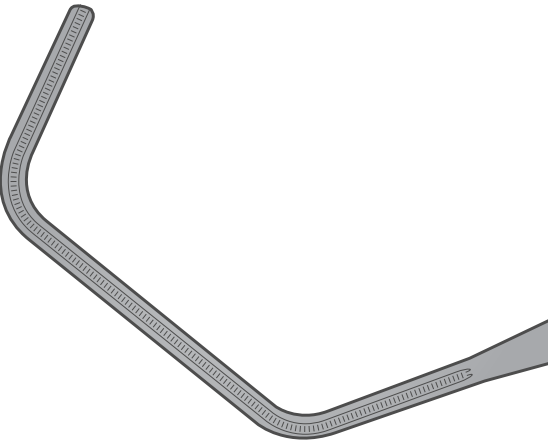

SCANLAN®
Hunter-Satinsky Aortic Clamps

	Cat. No.	Description	Total Length
	2002-116	4.0 cm jaws Blunted Potts Teeth Jaws	8 3/4" (22 cm)
	2002-117	3.5 cm Jaws DeBakey Jaws	

Please Note...

Each Scanlan instrument is individually handcrafted to provide the surgeon with the highest quality, longest-lasting, precision instrument possible. Reflecting this unique process, all stated dimensions are approximate.

2002-44

Stainless Steel CLAMPS



SCANLAN®
Aortic Aneurysm Clamps
 DeBakey Jaws

Instrument jaws are shown approximate size

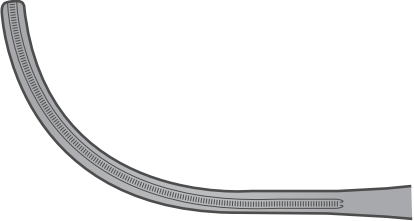
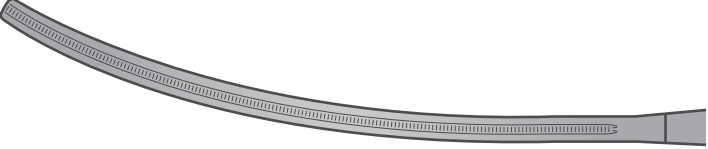
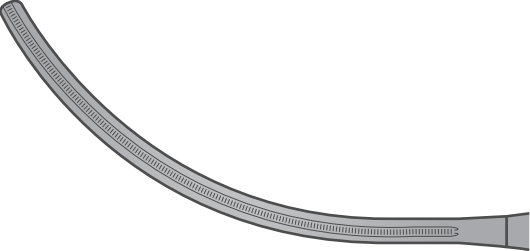
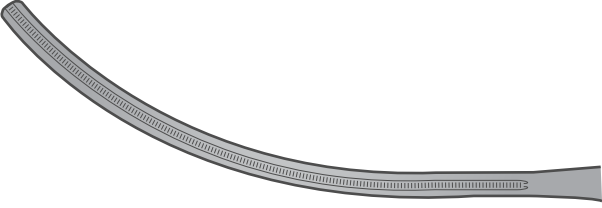
	Cat. No.	Description	Total Length
	2002-46	5 cm Jaws	8 1/2" (21.5 cm)
	2002-44	8 cm Curved Jaws Reversed Handle Curvature	10 1/4" (26 cm)
	2002-48	7 cm Jaws	10 3/4" (27.3 cm)
	2002-50	7.5 cm Jaws	11" (28 cm)

Please check with your Scanlan Representative for Firm Sale status. Custom modifications available upon request.
 For a complete listing of models visit... www.scanlaninternational.com



Stainless Steel CLAMPS

2002-22



SCANLAN®
Aortic Aneurysm Clamps
DeBakey Jaws

	Cat. No.	Description	Total Length
	2002-22	5.0 cm Jaws	10 3/4" (27.3 cm)

Please Note...

Each Scanlan instrument is individually handcrafted to provide the surgeon with the highest quality, longest-lasting, precision instrument possible. Reflecting this unique process, all stated dimensions are approximate.

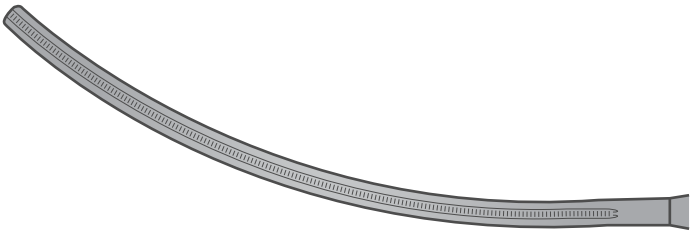

SCANLAN®
Pollack Aortic Clamps
 DeBakey Jaws

	Cat. No.	Description	Total Length
	2002-54	8.0 cm Jaws	10" (25.4 cm)

Please check with your Scanlan Representative for Firm Sale status. Custom modifications available upon request.
 For a complete listing of models visit... www.scanlaninternational.com



5005-80

Instrument is shown approximate size

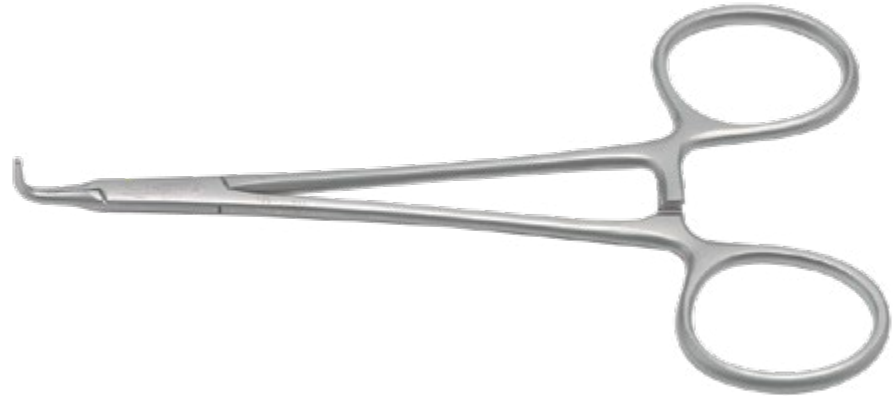

SCANLAN®
Phlebectomy Haemostat

Instrument jaws are shown approximate size

	Cat. No.	Description	Total Length
	5005-80	90° Angled Very Fine Jaws Sharp Grasping Serrations	4 1/2" (11.5 cm)

9009-148

Instrument is shown approximate size

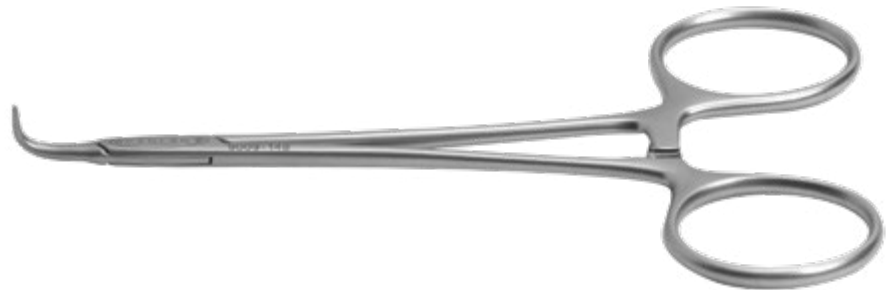

SCANLAN®
Ochsner Forceps

Instrument jaws are shown approximate size

	Cat. No.	Description	Total Length
	9009-148	90° Angled Very Fine Serrated Jaws	4 1/2" (11.5 cm)

Please Note...

Each Scanlan instrument is individually handcrafted to provide the surgeon with the highest quality, longest-lasting, precision instrument possible. Reflecting this unique process, all stated dimensions are approximate.

5005-64



Instrument is shown approximate size

Stainless Steel CLAMPS



SCANLAN®
Bailey Forceps

Instrument jaws are shown approximate size

	Cat. No.	Description	Total Length
	5005-60	30° Angled Jaws Very Fine Angled Serrated Jaws	7" (18 cm)
	5005-62	60° Angled Jaws Very Fine Angled Serrated Jaws	
	5005-64	90° Angled Jaws Very Fine Angled Serrated Jaws	



5005-00

Instrument is shown approximate size



SCANLAN®
Hartman Mosquito Forceps

Instrument jaws are shown approximate size

	Cat. No.	Description	Total Length
	5005-00	Curved Jaws	3 7/8" (9.8 cm)
	5005-001	Straight Jaws	

Please check with your Scanlan Representative for Firm Sale status. Custom modifications available upon request.
For a complete listing of models visit... www.scanlaninternational.com



5005-02





Instrument is shown approximate size



SCANLAN®

Vascular Mosquito Forceps

Instrument jaws are shown approximate size

	Cat. No.	Description	Total Length
	5005-01	Straight Serrated Jaws	5" (12.7 cm)
	5005-02	Delicate Curved Serrated Jaws	4 3/4" (12 cm)
	5005-03	Curved Jaws	5" (12.7 cm)
	5005-82	Curved Jaws Sharp Grasping Serrations	5" (12.7 cm)
	5005-05	Full Curved Jaws	4 1/2" (11.5 cm)

Please Note...

Each Scanlan instrument is individually handcrafted to provide the surgeon with the highest quality, longest-lasting, precision instrument possible. Reflecting this unique process, all stated dimensions are approximate.

5005-86

Instrument is shown approximate size



Stainless Steel CLAMPS

SCANLAN®
Delicate Mosquito Forceps

Instrument jaws are shown approximate size

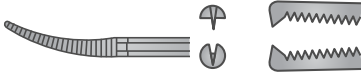
	Cat. No.	Description	Total Length
	5005-86	Very Fine Curved Jaws	5" (12.7 cm)
	5005-88	Curved Jaws 1 x 2 Teeth	

Please check with your Scanlan Representative for Firm Sale status. Custom modifications available upon request.
For a complete listing of models visit... www.scanlaninternational.com



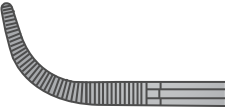
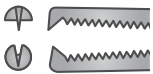
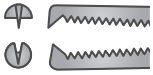

SCANLAN®
Vascular Forceps

Instrument jaws are shown approximate size		Cat. No.	Description	Total Length
		5005-13		5 1/2" (14 cm)
		5005-23	Curved Serrated Jaws	6 1/2" (16.5 cm)
		5005-33		7 1/4" (18.5 cm)
		5005-15		5 1/3" (13.7 cm)
		5005-25	Full Curved Serrated Jaws	6 1/4" (16 cm)
		5005-35		7" (18 cm)
		5005-37	Straight Jaws 1 x 2 Teeth	7" (18 cm)
		5005-39	Curved Jaws 1 x 2 Teeth	7" (18 cm)

Please Note...

Each Scanlan instrument is individually handcrafted to provide the surgeon with the highest quality, longest-lasting, precision instrument possible. Reflecting this unique process, all stated dimensions are approximate.

5005-43
Instrument is shown approximate size



Stainless Steel CLAMPS

SCANLAN®
Adson Forceps

Instrument jaws are shown approximate size

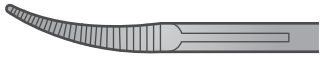
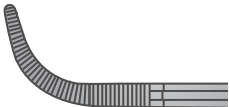
	Cat. No.	Description	Total Length
	5005-43	Curved Serrated Jaws	7" (18 cm)
	5005-45	Full Curved Serrated Jaws	

Please check with your Scanlan Representative for Firm Sale status. Custom modifications available upon request.
For a complete listing of models visit... www.scanlaninternational.com



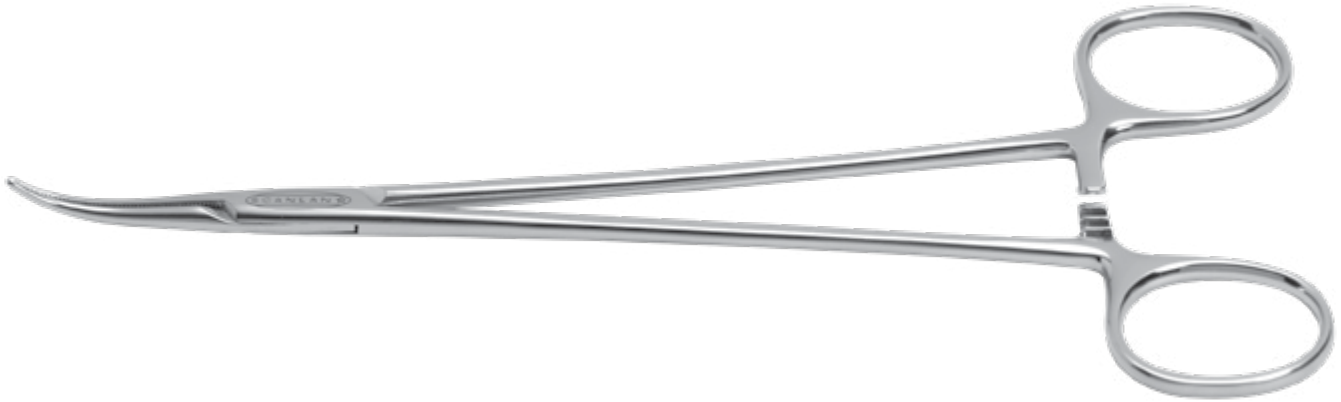

SCANLAN®
Bengolea Forceps

Instrument jaws are shown approximate size

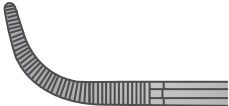
	Cat. No.	Description	Total Length
	5005-47	Curved Serrated Jaws	8" (20 cm)
	5005-51		9 1/2" (24 cm)
	5005-49	Full Curved Serrated Jaws	7 3/4" (19.5 cm)
	5005-53		9" (23 cm)

Please Note...

Each Scanlan instrument is individually handcrafted to provide the surgeon with the highest quality, longest-lasting, precision instrument possible. Reflecting this unique process, all stated dimensions are approximate.

4447-07

Instrument is shown approximate size



Stainless Steel CLAMPS

SCANLAN®
Crafoord Artery Forceps

Instrument jaws are shown approximate size

	Cat. No.	Description	Total Length
	4447-07	Curved Serrated Jaws	7" (18 cm)
	4447-09		9 1/4" (23.5 cm)

Please check with your Scanlan Representative for Firm Sale status. Custom modifications available upon request.

For a complete listing of models visit... www.scanlaninternational.com



Stainless Steel CLAMPS



SCANLAN®
DeBakey Cooley Forceps
 Carmalt Jaws with Cross Hatch Tips

Instrument jaws are shown approximate size

	Cat. No.	Description	Total Length
	4375-08	Curved Jaws	7 1/2" (19 cm)
	4375-09		9" (23 cm)
	4375-10		10" (25.4 cm)
	4375-11		11" (28 cm)
	4375-12		12" (30.5 cm)
	4375-14		14" (35.6 cm)

Please Note...

Each Scanlan instrument is individually handcrafted to provide the surgeon with the highest quality, longest-lasting, precision instrument possible. Reflecting this unique process, all stated dimensions are approximate.

4377-08

Stainless Steel CLAMPS



SCANLAN®
DeBakey Cooley Forceps
 Carmalt Jaws with Cross Hatch Tips

Instrument jaws are shown approximate size

	Cat. No.	Description	Total Length
	4377-08	Right Angle Jaws	7 1/2" (19 cm)
	4377-09		9" (23 cm)
	4377-11		11" (28 cm)
	4377-12		12" (30.5 cm)

Please check with your Scanlan Representative for Firm Sale status. Custom modifications available upon request.
 For a complete listing of models visit... www.scanlaninternational.com



Stainless Steel CLAMPS

4377-30



4377-28



SCANLAN®

MacDougall Clamp

Carmalt Jaws with Cross Hatch Tips

Instrument jaws are shown approximate size

	Cat. No.	Description	Total Length
	4377-28	Shanks Angled Left	12" (30.5 cm)
	4377-30	Shanks Angled Right	

Please Note...

Each Scanlan instrument is individually handcrafted to provide the surgeon with the highest quality, longest-lasting, precision instrument possible. Reflecting this unique process, all stated dimensions are approximate.

4545-09



Stainless Steel CLAMPS

SCANLAN®

Prostatectomy Clamp

Cat. No.	Description	Total Length
4545-09	45° Angled Babcock Jaws 8 mm Width Jaws Curved Shanks	9" (23 cm)

Haemostats | Specialty | Allis Intestinal

4635-06

Instrument is shown approximate size



SCANLAN®

Allis Intestinal Clamp

Cat. No.	Description	Total Length
4635-06	4 mm Width Jaws	6" (15 cm)

Please check with your Scanlan Representative for Firm Sale status. Custom modifications available upon request.

For a complete listing of models visit... www.scanlaninternational.com

1001-54

Instrument is shown approximate size



SCANLAN®

Smith Leifer Vasectomy Forceps

Cat. No.	Description	Total Length
1001-54	Sharp Tips	7" (18 cm)

Please Note...

Each Scanlan instrument is individually handcrafted to provide the surgeon with the highest quality, longest-lasting, precision instrument possible. Reflecting this unique process, all stated dimensions are approximate.